

Department of Agriculture  
Bureau of Ride & Measurement Standards  
Division of Amusement Rides

# CERTIFIED INSPECTOR STUDY MATERIAL

## TABLE OF CONTENTS

Page 2: Introduction by Walter Remmert, Bureau Director

Page 3-38: Amusement Ride Regulations

Pages 39-53: Ride Operators Manual

Pages 54-123: General Study Material

Dear Ride or Attraction Operator:

In order to prepare yourself for the Amusement Ride Inspector test, it will be necessary for you to become familiar with our **study material and regulations**. Enclosed is a copy of the Act, the Regulations, and study guide for your review. This information covers the essential areas of Amusement Ride inspections and should be beneficial in preparing for the test.

You are required to attend a seminar at least one within each three-year certification period. The seminar alone does not prepare you for the test. If you have not yet attended the required seminar, we will extend a one-time grace period until the next seminar so you can comply immediately.

Also enclosed is an application to become a Qualified Amusement Ride Inspector in the Commonwealth of Pennsylvania. Please complete the enclosed application and return it to this office as soon as possible for review or bring it with you when you take the inspector test at a seminar or our Harrisburg office.

The Amusement Ride Inspector test is administered by appointment throughout the year and during approved ride inspector safety seminars. If you wish to take the test, please contact Supervisor Joe Filoromo at 717-215-4316 or [jfiloromo@pa.gov](mailto:jfiloromo@pa.gov). This study material has been compiled to help the applicant prepare for the Certified Amusement Ride Safety Inspector Test. Not all information required to answer all the questions on the test can be found in this document.

The Department can and will change and up-date this material as the situation warrants. The Department reserves the right to limit the number of times an unsuccessful person can attempt to pass the test to three (3).

The Department assesses a fifty-dollar (\$50) certification fee, payable the day of the test. Make checks payable to "The Pennsylvania Department of Agriculture". The Department **cannot** accept cash.

Sincerely,



Walter Remmert, Director

Enclosures: Amusement Ride Safety Act, Amusement Ride Safety Regulations, Study Material and Inspector application.

**PART V-D. AMUSEMENT RIDES AND AMUSEMENT  
ATTRACTIONS**

Chap.		Sec.
<b>139.</b>	<b>AMUSEMENT RIDES AND ATTRACTIONS .....</b>	<b>139.1</b>
<b>139a.</b>	<b>SAFETY STANDARDS FOR BUNGEE JUMPING .....</b>	<b>139a.1</b>

**CHAPTER 139. AMUSEMENT RIDES AND ATTRACTIONS**

Subchap.		Sec.
<b>A.</b>	<b>REGISTRATION AND INSPECTION .....</b>	<b>139.1</b>
<b>B.</b>	<b>DESIGN AND CONSTRUCTION .....</b>	<b>139.41</b>
<b>C.</b>	<b>OPERATION, MAINTENANCE AND RECORDS .....</b>	<b>139.71</b>

**Authority**

The provisions of this Chapter 139 issued under the Amusement Ride Inspection Act (4 P. S. §§ 401—419), unless otherwise noted.

**Source**

The provisions of this Chapter 139 adopted April 11, 1986, effective April 12, 1986, 16 Pa.B. 1268, unless otherwise noted.

**Cross References**

This chapter cited in 7 Pa. Code § 139a.1 (relating to scope); 7 Pa. Code § 139a.21 (relating to registration of bungee jumping operations); 7 Pa. Code § 139a.51 (relating to qualifications of jump master); and 7 Pa. Code § 139a.92 (relating to penalties).

**Subchapter A. REGISTRATION AND INSPECTION**

Sec.	
139.1.	Scope.
139.2.	Definitions.
139.3.	Compliance.
139.4.	Registration.
139.5.	Insurance.
139.6.	Itinerary.
139.7.	Inspection.
139.8.	Inspection affidavits.
139.9.	Qualified inspectors.
139.10.	Advisory Board.
139.11.	Accident reporting.
139.12.	Variances.
139.13.	Penalties.
139.14.	Contacting the Department.

139-1

(339829) No. 411 Feb. 09

**§ 139.1. Scope.**

(a) This chapter prescribes policies and procedures relating to administration of safety standards for installation, assembly, repair, maintenance, use, operation, disassembly and inspection of amusement rides and amusement attractions erected permanently or temporarily at carnivals, fairs, amusement parks or any other location in this Commonwealth.

(b) This chapter applies to new and existing commercially used amusement rides and attractions subject to the act.

(c) This chapter does not apply to:

(1) An attraction principally devoted to the exhibition of products of agriculture, industry, education, science, religion or the arts.

(2) Single passenger, coin-operated, manually, mechanically or electrically operated rides except where admission is charged for the use of the equipment.

(3) Licensed watercraft regulated by the Fish Commission or the United States Coast Guard.

(4) Aircraft regulated by the Federal Aviation Administration.

(5) Devices, including trains, regulated by the United States Government.

(6) Ski lifts, elevators or rides to the extent they are registered and regulated by any other agency of the Commonwealth.

(7) Amusement attractions, and amusement rides regulated by another Commonwealth agency and waterslides, to the extent that they are regulated by the Department of Health for pool design, sanitary facilities and similar features.

**Authority**

The provisions of this § 139.1 issued under: the Amusement Ride Inspection Act (4 P. S. §§ 401—419); amended under: section 14 of the Amusement Ride Inspection Act (4 P. S. § 414).

**Source**

The provisions of this § 139.1 adopted April 11, 1986, effective April 12, 1986, 16 Pa.B. 1268; amended July 31, 1987, effective August 1, 1987, 17 Pa.B. 3202; amended December 12, 2008, effective December 13, 2008, 38 Pa.B. 6843. Immediately preceding text appears at serial page (276962).

**§ 139.2. Definitions.**

The following words and terms, when used in this chapter, have the following meanings, unless the context clearly indicates otherwise:

*Act*—The Amusement Ride Inspection Act (4 P. S. §§ 401—419).

*Affiliated qualified inspector*—A qualified inspector with a Department-issued certificate and credential card authorizing that person to act as a qualified inspector only with respect to the amusement rides or amusement attractions of the owner or lessee designated on that certificate and credential card. An affiliated qualified inspector is not a general qualified inspector.

*Amusement attraction*—

(i) A building or structure around, over or through which people may move or walk, without the aid of a moving device integral to the building or structure, that provides amusement, pleasure, thrills or excitement.

(ii) The term does not include an enterprise principally devoted to the exhibition of products of agriculture, industry, education, science, religion or the arts.

*Amusement park*—A tract or area used principally as a location for permanent amusement structures or rides.

*Amusement ride*—A device that carries, suspends or conveys passengers along, around or over a fixed or restricted route or course or within a defined area, for the purpose of giving its passengers amusement, pleasure, thrills or excitement.

*ASTM*—*American Society for Testing Materials*—This organization is currently named and known as ASTM International.

*ASTM International*—The organization formerly known as ASTM or the American Society for Testing Materials.

*ASTM International F-24 Committee Standards*—The ASTM standards promulgated by the ASTM International F-24 Committee, as published in the current annual book of ASTM International Standards Volume 15.07, or its successor document.

*ASTM standards*—Standards promulgated by the ASTM entitled *Standard Guide for the Classification of Amusement Ride and Device Related Injuries and Illnesses*, designation ASTM F 1305, or its successor, which provide procedures for the uniform classification of data related to amusement ride and device injuries and illnesses.

*Attendant*—A person having responsibility for some aspect of the operation of an amusement ride or attraction, but who is not an operator.

*Board*—The Amusement Ride Safety Advisory Board.

*Carnival*—An itinerant enterprise consisting principally of temporary amusement structures or mechanical rides.

*Class I amusement ride or amusement attraction*—A type of amusement ride or amusement attraction with respect to which the following apply:

(i) The ride or attraction is on the Department's most current list of approved rides.

(ii) The ride or attraction is a comparatively simple ride such as bumper cars, bumper boats, a multipassenger coin-operated kiddie ride, go-carts, a live animal ride, a manually powered ride, a miniature train, an inflatable bounce ride, slide or similar device.

(iii) The Department has, on its most current list of approved rides, designated the ride or attraction as belonging within "Class I" for purposes of establishing the appropriate required minimum liability insurance coverage required with respect to that ride or attraction, in accordance with section 14(a)(1) of the act (4 P. S. § 414(a)(1)).

*Class II amusement ride or amusement attraction*—A type of amusement ride or amusement attraction with respect to which the following apply:

(i) The ride or attraction is on the Department's most current list of approved rides.

(ii) The Department has, on its most current list of approved rides, designated the ride or attraction as belonging within "Class II" for purposes of establishing the appropriate required minimum liability insurance coverage required with respect to that ride or attraction, in accordance with section 14(a)(2) of the act.

*Commercially used*—In the context of amusement rides and amusement attractions, the term includes any ride or attraction offered for use by persons in consideration of payment of a ticket fee, an entry fee, a rental fee or any other fee or charge as a condition of use of the ride or attraction.

*Department*—

(i) The Department of Agriculture of the Commonwealth.

(ii) The term includes employees of the Department.

*Fair*—An enterprise principally devoted to the periodic and recurring exhibition of products of agriculture, industry, education, science, religion or the arts that has one or more amusement rides or attractions operated in conjunction therewith in either temporary or permanent structures.

*General qualified inspector*—A qualified inspector with a Department-issued certificate and credential card authorizing that person to act as a qualified inspector, without limiting the exercise of that inspection authority to the amusement rides or amusement attractions of a particular owner or lessee. A general qualified inspector is not an affiliated qualified inspector.

*Inspection*—Inspection by a qualified inspector of an amusement ride, device or attraction for compliance with the act and this chapter.

*Kiddy ride or kiddie ride*—An amusement ride or attraction designed primarily for use by children up to 12 years of age.

*Lessee*—A person who leases an amusement ride or attraction from its owner, or from an authorized representative of an owner.

*Major modification*—A change in either the structural or operational characteristics of an amusement ride or amusement attraction which can alter its performance from that specified in the manufacturer's design criteria.

*Major ride*—An amusement ride or attraction that is not a kiddy ride.

*National Electrical Code*—The National Electrical Code NFPA No. 70-E, as revised, amended or corrected.

*New amusement ride or amusement attraction*—An amusement ride or attraction of a design not previously operated in this Commonwealth and for which no regulations have been adopted.

*Operation*—

(i) When used in the context of an amusement ride or attraction, the term includes the loading of persons onto the ride or attraction, the physical

movement of the ride or—in the case of nonmechanical rides (such as slides) or attractions—the movement of persons on or through the ride or attraction, and the unloading of persons from the ride or attraction.

(ii) The term does not include the portion of a patron line that extends outside of any fence, wall, guardrail or gate that limits access to the amusement ride or amusement attraction and that is required in order for the ride or attraction to meet the ASTM International F-24 Committee Standards.

(iii) The term does not include that portion of a patron line that extends outside or beyond any device or object that limits or identifies control access for the ride or attraction if a fence, wall, guardrail or gate is not required in order for the ride or attraction to meet ASTM International F-24 Committee Standards.

*Operator*—A person actually engaged in or directly controlling the operation of an amusement ride or attraction.

*Owner*—

(i) A person who owns an amusement ride or attraction.

(ii) The term excludes the Commonwealth or its political subdivisions. *Pennsylvania Construction Code Act*—35 P. S. §§ 7210.101—7210.1103.

*Permanent structure*—A structure, enclosure or arrangement of parts, used or intended to be used for or as an amusement ride or attraction, that is erected to remain a lasting part of the premises.

*Person*—Includes a corporation, partnership, limited liability company, business trust, other association, government entity (other than the Commonwealth), estate, trust, foundation or natural person.

*Professional engineer*—

(i) An individual licensed and registered under the Engineer, Land Surveyor and Geologist Registration Law (63 P. S. §§ 148—158.2) or a successor statute to engage in the practice of engineering.

(ii) The term does not include a person who is exempt from licensure and registration under section 5(b) of the Engineer, Land Surveyor and Geologist Registration Law (63 P. S. § 152(b)).

*Qualified inspector*—

(i) A person certified by the Department who by education, training or experience is knowledgeable with amusement ride operating manuals and the psychological effects each ride has upon a passenger. The person shall also be experienced in the erection and dismantling of amusement rides and shall be familiar with the specific equipment with that particular operator.

(ii) The term includes affiliated qualified inspectors and general qualified inspectors.

*Secretary*—The Secretary of the Department.

*Serious injury or illness*—

(i) An injury or illness that requires one or more of the following:

(A) Offsite emergency first aid.

(B) Offsite medical treatment, whether it is administered or recommended or may be required at a future date.

(C) Observation by a licensed physician.

(D) Admission to a hospital.

(ii) The term also includes an injury or illness that results in death, dismemberment, significant disfigurement or permanent loss of the use of a body organ, member, function or system.

*Temporary structure*—A structure, enclosure or arrangement of parts used, or intended to be used for or as an amusement ride or attraction, that is relocated from time to time with or without disassembly.

*Working day*—A day other than a Saturday, Sunday, National holiday or holiday of the Commonwealth.

#### Source

The provisions of this § 139.2 amended December 12, 2008, effective December 13, 2008, 38 Pa.B. 6843. Immediately preceding text appears at serial pages (276962) to (276964).

#### Cross References

This section cited in 7 Pa. Code § 139.11 (relating to accident reporting).

### § 139.3. Compliance.

(a) *General requirement.* Owners, lessees and operators of amusement rides or attractions in this Commonwealth shall comply with this chapter.

(b) *Use of nonconforming rides or attractions prohibited.* An amusement ride or amusement attraction which is not in compliance with this chapter may not be used or occupied except as provided in subsection (c).

(c) *Nonconforming individual units.* Where only individual units of a ride, such as cars, seats or other carriers are defective and not in compliance with this chapter, the units shall either be removed from the operating area of the ride or shall be taken out of service and clearly marked with a sign reading “Out of Service” if the defects or removal do not jeopardize the safety of the entire ride or attraction.

#### Source

The provisions of this § 139.3 amended December 12, 2008, effective December 13, 2008, 38 Pa.B. 6843. Immediately preceding text appears at serial page (276964).

### § 139.4. Registration.

(a) *Registration required.* An owner intending to operate or use an amusement ride or an amusement attraction in this Commonwealth during a calendar year shall register the amusement ride or amusement attraction with the Department prior to operation.

(b) *Duration of registration.* Registration of an amusement ride or an amusement attraction shall expire as of the earlier of the following:

139-6



(1) January 1 of the year immediately following the year with respect to which the registration is issued.

(2) The date upon which the registered amusement ride or amusement attraction undergoes a major modification.

(c) *Obtaining a registration application.* A person may obtain an amusement ride or amusement attraction registration application form by contacting the Department as described in § 139.14 (relating to contacting the Department). The Department will provide the form upon request, and make the form available for download through the Department's web site: [www.agriculture.state.pa.us](http://www.agriculture.state.pa.us).

(d) *Contents of registration application form.* A registration application form will require the following information:

(1) The name, address, e-mail address and telephone number of the owner.

(2) The name, address, e-mail address and telephone number of the lessee, if different than the owner.

(3) If the amusement ride or amusement attraction has previously been registered, the registration number appearing on the registration plate issued by the Department and attached to that ride or attraction.

(4) A description of the type of enterprise involved, whether a carnival, fair, park, rental company, go-cart track, water park, nonseasonal operation, or other.

(5) A list of each amusement ride or amusement attraction with respect to which registration is sought, by name, manufacturer's name and serial number.

(6) The name, address, e-mail address and telephone number of the insurance carriers providing the owner, lessee or operator the liability coverage required under section 14 of the act (4 P. S. § 414) and § 139.5 (relating to insurance).

(7) With respect to each identified amusement ride or attraction, verification of one of the following:

(i) The amusement ride or amusement attraction is of a type appearing on the Department's most current list of approved rides.

(ii) Written verification under seal of a professional engineer, acknowledging familiarity with the ride or attraction at issue, acknowledging familiarity with the requirements of the act and this chapter and confirming all of the following:

(A) The ride or attraction is designed to carry all loads safely, and to withstand normal stresses to which it may be subjected.

(B) The structural materials and construction of the ride or attraction conform to normal engineering practices, procedures, standards and specifications.

(C) Data pertinent to the design, structures, and factors of safety and performance are in accordance with accepted engineering practices.

(D) The manufacturer or fabricator of the ride or attraction otherwise meets the applicable design and construction requirements of the act, the ASTM International F-24 Committee Standards and this chapter.

(8) An acknowledgment by the applicant that, if the registration is approved, it is the responsibility of the applicant to apprise the Department, in writing, of changes to the information provided on the registration application during the registration period.

(9) An acknowledgment by the applicant that, if registration is approved, the registration automatically ceases as of the date of any major modification, and the ride shall be reregistered with the Department.

(10) The signature of the applicant for registration, verifying that representations in the application are accurate and complete, and making that verification subject to the penalties of 18 Pa.C.S. § 4904 (relating to unsworn falsification to authorities).

(e) *Department action on registration application.* The Department will, within 30 days of receiving a correct and complete registration application form, mail the applicant one of the following:

(1) Written confirmation of registration and, if necessary, a registration plate to be affixed to the amusement ride or attraction.

(2) Written denial of registration, with an explanation of the reasons for denial.

(3) A detailed request for additional information or clarification the Department deems necessary to ensure the amusement ride or amusement attraction meets the requirements in subsection (d)(7)(ii)(A)—(D). This request may also include a requirement the ride or attraction be made available to the Department or persons authorized by the Department, at a time or location mutually agreeable to the applicant and the Department, for inspection and testing. Once the requested information is delivered to the Department or the requested testing and inspection is conducted, the Department will have an additional 30-day period within which to review the registration application.

(f) *Responsibility of registrant.* A person who registers an amusement ride or amusement attraction in accordance with this section shall, during the registration period, be responsible to apprise the Department, in writing, of changes to the information provided on the registration application. In addition, the registrant shall affix the registration plate provided by the Department to the amusement ride or amusement attraction in a location where the plate is plainly visible to the riding public, and shall promptly request a replacement plate when necessary.

(g) *Refusal or revocation of registration.* If the Department issues a written denial of registration as described in subsection (e)(2), it will afford the applicant an opportunity for an administrative hearing on the denial. If the Department has reason to believe an amusement ride or amusement attraction that is registered

does not meet the requirements for registration, it will issue a written revocation of registration, and will afford the applicant an opportunity for an administrative hearing on the denial.

(h) *Registration plate.* The Department will issue a registration plate, bearing a unique registration number, with respect to each amusement ride or amusement attraction registered in accordance with this section. The registration plate remains the property of the Department after it is issued. The registrant shall be responsible to ensure that the registration plate remains affixed to the registered amusement ride or amusement attraction in a location where the plate is plainly visible to the riding public. The registration plate is intended as a permanent means of identifying the amusement ride or attraction, and shall remain affixed to the ride or attraction from one registration period to the next. If the registration plate cannot be affixed to the registered amusement ride or amusement attraction in a location where the plate is plainly visible to the riding public, it may be affixed to a sign, placard or surface at the point of ingress to the ride or attraction, so as to be plainly visible to the riding public, and shall physically accompany the ride or attraction at all times. Although the Department will not charge a fee for the issuance of a registration plate, it will charge a registrant \$30 to replace a lost or obliterated registration plate. This charge reflects the reasonable cost to the Department of replacing a registration plate.

(i) *Inspection of amusement rides or amusement attractions.* The Department may inspect any amusement ride or attraction, or any device or location it reasonably believes to be an amusement ride or attraction, to determine whether the ride or attraction is properly registered. The inspection will be conducted in accordance with § 139.7(d) (relating to inspection).

#### Source

The provisions of this § 139.4 amended December 12, 2008, effective December 13, 2008, 38 Pa.B. 6843. Immediately preceding text appears at serial page (276964).

#### Cross References

This section cited in 7 Pa. Code § 139.8 (relating to inspection affidavits); and 7 Pa. Code § 139a.21 (relating to registration of bungee jumping operations).

### § 139.5. Insurance.

(a) *General requirement.* A person may not operate an amusement ride or amusement attraction unless a policy of insurance is in effect insuring the owner, lessee or operator against liability for injury to persons arising out of the use of an amusement ride or attraction. The insurance policy shall be procured from an insurer or surety authorized to do business in this Commonwealth or eligible to do business under the surplus lines insurance provisions established under Article XVI of The Insurance Company Law of 1921 (40 P. S. §§ 991.1601—991.1625).

139-9

(339837) No. 411 Feb. 09

(1) If the ride or attraction is a Class I amusement ride or attraction, the minimum limits of the policy must be \$100,000 per occurrence and \$300,000 in the aggregate.

(2) If the ride or attraction is a Class II amusement ride or amusement attraction, the minimum limits of the policy must be \$250,000 per occurrence and \$500,000 in the aggregate.

(b) *Certificate of insurance.* An owner or operator shall deliver a valid certificate of insurance to the Department prior to the operation of an amusement ride or amusement attraction for use by the public. The certificate of insurance shall be delivered to the Department in accordance with § 139.14 (relating to contacting the Department). The owner or operator is responsible for assuring that the insuring company notifies the Department immediately upon cancellation or change of coverage.

(c) *Content of certificate of insurance.* A certificate of insurance must set forth the following:

(1) The identity of the insured.

(2) The identity, address and telephone number of the insurance company issuing the policy.

(3) Identification of the amusement rides and amusement attractions covered by the policy. This may consist of a roster identifying each ride that is insured under the policy, or an acknowledgment that all of the amusement rides and amusement attractions of a designated owner or operator are covered by the policy.

(4) The policy limits per occurrence.

(5) The policy limits in the aggregate.

(6) The effective dates of coverage.

(7) An acknowledgment that the Department, as certificateholder, is to be notified by the insurance carrier in the event of cancellation of coverage.

#### Authority

The provisions of this § 139.5 issued under the Amusement Ride Inspection Act (4 P. S. §§ 401—419); amended under: section 14 of the Amusement Ride Inspection Act (4 P. S. § 414).

#### Source

The provisions of this § 139.5 adopted April 11, 1986, effective April 12, 1986, 16 Pa.B. 1268; amended July 31, 1987, effective August 1, 1987, 17 Pa.B. 3202; amended December 12, 2008, effective December 13, 2008, 38 Pa.B. 6843. Immediately preceding text appears at serial pages (276964) to (276965).

#### Cross References

This section cited in 7 Pa. Code § 139.4 (relating to registration); and 7 Pa. Code § 139a.21 (relating to registration of bungee jumping operations).

#### 139-10

(339838) No. 411 Feb. 09

Copyright © 2009 Commonwealth of Pennsylvania

**§ 139.6. Itinerary.**

The owner or operator of an amusement park, carnival, fair, or other itinerant amusement ride or amusement attraction registered with the Department shall deliver an itinerary to the Department at least 15 days prior to the operation of a ride or attraction for use by the public in this Commonwealth. This delivery may be accomplished by mail, e-mail, personal delivery or fax transmission to the fax number provided in § 139.14 (relating to contacting the Department). The itinerary must include the following:

- (1) The name of the amusement ride or amusement attraction owner.
- (2) The park owner.
- (3) The carnival, fair, activity sponsor and, if available, the name and telephone number of a contact person for the event.
- (4) The address and telephone number of the activity site, the fax number of the site (if available) and an e-mail address for the site (if available).
- (5) The dates open to the public.
- (6) The name of a contact person on site if available.

**Source**

The provisions of this § 139.6 amended December 12, 2008, effective December 13, 2008, 38 Pa.B. 6843. Immediately preceding text appears at serial page (276965).

**§ 139.7. Inspection.**

(a) *General inspection requirement.* An owner or lessee of an amusement ride or amusement attraction shall have the ride inspected in accordance with section 7 of the act (4 P. S. § 407) and this chapter.

(b) *Occasions when inspection is required.* An amusement ride or amusement attraction shall be inspected as follows:

<i>Location</i>	<i>Type</i>	<i>Interval</i>
Any location	Amusement ride or amusement attraction	Prior to operation for the riding public, and on a monthly basis thereafter during a season of operation for use by the riding public (inspections may be discontinued at the end of a season of operation for the riding public, but shall be resumed prior to any operation for the riding public that is to occur outside of the normal season of operation)

<i>Location</i>	<i>Type</i>	<i>Interval</i>
Amusement park	Amusement ride or amusement attraction	Prior to operation for the riding public, and on a monthly basis thereafter during a season of operation for use by the riding public (inspections may be discontinued at the end of a season of operation for the riding public, but shall be resumed prior to any operation for the riding public that is to occur outside of the amusement park's normal season of operation)
Fair or carnival	Amusement ride or amusement attraction	Prior to operation for the riding public at each new location
Any location	New amusement ride or amusement attraction	Prior to operation for the riding public
Any location	Amusement ride or amusement attraction that has undergone major modification	Prior to operation for the riding public

(c) *Qualified inspector to conduct inspection.* The amusement ride or amusement attraction owner or lessee shall engage a qualified inspector to perform the inspections required by the act and this chapter. The owner or lessee shall make the amusement ride or amusement attraction available to the qualified inspector. The owner or lessee shall be solely responsible for expenses in connection with the inspection. The qualified inspector shall, at the conclusion of an inspection, issue the owner or lessee the original plus one copy of a complete inspection affidavit form, as described in § 139.8 (relating to inspection affidavits), and retain a copy for the qualified inspector's records.

(d) *Inspection by the Department.* The Department may inspect any amusement ride or amusement attraction (including the operation of that amusement ride or amusement attraction), or any device or location it reasonably believes to be an amusement ride or amusement attraction, to determine whether the ride or attraction is properly registered, whether the ride or attraction has been inspected by a qualified inspector, whether the qualified inspector has performed a competent inspection of the ride or attraction and whether the ride or attraction otherwise complies with the act and this chapter. The inspection may be unannounced or with advance notice to the owner or lessee. The Department will endeavor to

conduct these inspections at reasonable times and with a minimum intrusion, unless otherwise necessary to safeguard the public.

(e) *Responsibility of owner, lessee or operator to allow inspection.* An owner, lessee or operator shall allow the Department to inspect an amusement ride or amusement attraction, and may not hinder or impede the Department in the performance of the inspection.

(f) *Responsibility of owner, lessee or operator to produce records.* At the request of the Department, an owner, lessee or operator shall produce documentation as to both the operation and maintenance of an amusement ride or amusement attraction.

#### Source

The provisions of this § 139.7 amended December 12, 2008, effective December 13, 2008, 38 Pa.B. 6843. Immediately preceding text appears at serial page (276966).

#### Cross References

This section cited in 7 Pa. Code § 139.4 (relating to registration); and 7 Pa. Code § 139a.26 (relating to cranes).

### § 139.8. Inspection affidavits.

(a) *Inspection affidavit required.* An owner or lessee shall, with respect to each amusement ride or amusement attraction that is to be operated for use by the public, file a written affidavit with the Department, affirmed by a qualified inspector, that the amusement ride or amusement attraction has been inspected in accordance with the requirements of the act and this chapter, and meets those requirements. A single inspection affidavit may pertain to multiple amusement rides or amusement attractions.

(b) *Filing the inspection affidavit.* An owner or lessee shall file an inspection affidavit with the Department within 48 hours of the inspection. Filing shall be accomplished in accordance with § 139.14 (relating to contacting the Department).

(c) *Copy of inspection affidavit to be retained for inspection onsite.* An owner or lessee shall be responsible to ensure that a copy of the inspection affidavit described in subsection (b) is retained at the site where the amusement ride or amusement attraction is being operated for public use. The inspection affidavit shall be made available for inspection upon request of the Department. The Department may retain the onsite copy of the inspection affidavit, provide the owner, lessee, operator or attendant a receipt for the same, and allow the amusement ride or amusement attraction to continue being operated for public use.

(d) *Notice of compliance to be posted.* An owner or lessee of an amusement ride or amusement attraction shall post a notice advising the public of compliance with the act. This notice is in addition to any registration plate issued in accor-

dance with § 139.4 (relating to registration). The notice shall be posted at a place readily observed by the public and consist of a sign made of durable material suitable for the location where it is posted. The notice must be on a bright green background, with white lettering. The size of the letters must be at least 1/2 inch in height and 1/8 inch width stroke reading:

THIS RIDE HAS (OR ALTERNATE—THE RIDES IN THIS PARK, CARNIVAL, FAIR, ETC. HAVE) BEEN INSPECTED AS REQUIRED BY THE PENNSYLVANIA AMUSEMENT RIDE INSPECTION ACT.

#### Source

The provisions of this § 139.8 amended December 12, 2008, effective December 13, 2008, 38 Pa.B. 6843. Immediately preceding text appears at serial page (276966).

#### Cross References

This section cited in 7 Pa. Code § 139.7 (relating to inspection); and 7 Pa. Code § 139.9 (relating to qualified inspectors).

### § 139.9. Qualified inspectors.

(a) *General.* The Department will certify persons who meet the requirements of this section to act as qualified inspectors. Any inspection of an amusement ride or amusement attraction required under the act shall be conducted by a qualified inspector who is certified by the Department with respect to the category of amusement ride or amusement attraction that is being inspected. Persons who have been certified by the Department as qualified inspectors prior to December 13, 2008, may continue to inspect amusement rides and attractions under authority of that certification, but shall meet the requirements of this section when the qualified inspector next renews the certification in accordance with subsection (k).

(b) *Certification categories.* The Department will categorize amusement rides and attractions, and will be guided by ASTM categorizations of amusement rides and attractions in this categorization process. The Department will establish specific written tests or hands-on tests, or both, with respect to each category. These categories may address water rides, climbing walls, kiddie rides, train rides, hydraulics, inflatable rides or any other category described in ASTM standards and designated by the Department. The Department will publish the current list of certification categories on its web site ([www.agriculture.state.us](http://www.agriculture.state.us)). The Department may categorize an amusement ride or amusement attraction in a manner other than as categorized by ASTM if there is no applicable ASTM categorization or the Department, in its discretion, believes another categorization is more appropriate.

(c) *Application.* A person may apply to the Department to become a qualified inspector. A qualified inspector application form may be obtained by contacting



the Department through any means described in § 139.14 (relating to contacting the Department). The qualified inspector application form will require the following information:

- (1) The name, address and telephone number of the applicant.
  - (2) The e-mail address of the applicant (if it exists).
  - (3) The name, address and telephone number of the particular owner or lessee with respect to which the applicant seeks to become an affiliated qualified inspector, if the applicant seeks to be an affiliated qualified inspector.
  - (4) A detailed description of the education, training or experience of the applicant with respect to the safe erection, operation and dismantling of the amusement rides and attractions.
  - (5) The specific categories of amusement rides or amusement attractions with respect to which certification is sought.
  - (6) Verification that the applicant is at least 18 years of age as of the date of the qualified inspector application form.
  - (7) The signature of the applicant, verifying that representations made in the application are true and correct, and made subject to the penalties of 18 Pa.C.S. § 4904 (relating to unsworn falsification to authorities).
- (d) *Application fee.* The application fee with respect to a qualified inspector application form is \$50. This fee is not refundable, and shall be paid by check or money order made payable to the “Commonwealth of PA” in that amount.
- (e) *Filing the application.* An applicant shall submit a complete qualified inspector application form to the Department by mailing or delivering the form, together with the fee described in subsection (d), to the address in § 137.14.
- (f) *Department review and action.* The Department will promptly review an application to determine whether the application form is complete and will, within 30 days of receiving the application, provide the applicant the following by mail or electronic means:
- (1) An acknowledgment of receipt of the complete application.
  - (2) A schedule showing dates, times and locations of upcoming Qualified Inspector Tests, and instructions for scheduling the applicant to sit for the test.
  - (3) Written instructions as to how the applicant may download a Qualified Inspector Test study packet from the Department’s internet web site, receive a test study packet by e-mail or request the Department mail the applicant a test study packet.
- (g) *Qualified Inspector Test.* The Qualified Inspector Test shall be a written test or a hands-on test, or both, measuring the experience and ability of the applicant with respect to the safe erection, operation and dismantling of amusement rides or attractions that are in the category of amusement ride or amusement attraction with respect to which certification is sought. The test may address multiple categories of amusement rides and attractions. The Department will score a Qualified Inspector Test. The passing score for the test shall be 70% or higher.

The Department will report the results to the applicant by mail or electronic means within 30 days of the date of the qualified inspector test.

(h) *Qualified inspector's certificate and credential card.*

(1) If an applicant passes the Qualified Inspector Test, the Department will issue a certificate and a credential card identifying the applicant as a qualified inspector of amusement rides and attractions, specifying whether the person is an affiliated qualified inspector or a general qualified inspector, and setting forth the following:

- (i) The name of the qualified inspector and, on the credential card only, a photograph of the qualified inspector.
- (ii) The date of certification and the expiration date.
- (iii) The particular owner or lessee with respect to which the applicant is authorized to act as an affiliated qualified inspector, if the application does not specify an affiliation, if issued to an affiliated qualified inspector.
- (iv) The categories of amusement rides or attractions with respect to which the applicant is certified as a qualified inspector.

(2) The certificate and credential card will remain the property of the Department and shall, upon the written request of the Department, be surrendered to the Department. The applicant shall be responsible to coordinate with the Department to obtain the photograph required for the issuance of the credential card.

(i) *Powers of affiliated qualified inspectors and general qualified inspectors.*

(1) An affiliated qualified inspector may do the following:

(i) Conduct an inspection of an amusement ride or amusement attraction that is both of the following:

(A) Owned or leased by a person designated on the affiliated qualified inspector's certificate and credential card.

(B) Within a category with respect to which the qualified inspector is certified.

(ii) Issue inspection affidavits as described in § 139.8 (relating to inspection affidavits).

(iii) Charge a fee for conducting an inspection, but not a fee that varies with whether an amusement ride or amusement attraction passes or fails the inspection.

(2) A general qualified inspector may do the following:

(i) Conduct an inspection of an amusement ride or amusement attraction that is within a category with respect to which the qualified inspector is certified.

(ii) Issue inspection affidavits as described in § 139.8.

(iii) Charge a fee for conducting an inspection, but not a fee that varies with whether an amusement ride or amusement attraction passes or fails the inspection.

(j) *Duration of certification.* A qualified inspector's certification will expire 3 years from the date of certification, unless revoked or suspended earlier by the Department.

(k) *Renewal of current certificate and credential card.*

(1) A qualified inspector may renew certification by delivering to the Department, at the address in § 139.14 and prior to the expiration of the current certificate and credential card, a complete renewal form. A person may obtain this form by contacting the Department through any means described in § 139.14. The renewal form will require the information described in subsection (c)(1)—(7), and the following:

(i) A copy of a course completion certificate verifying that the applicant has met the continuing education requirement in subsection (l).

(ii) A nonrefundable \$50 application fee, by check or money order made payable to the "Commonwealth of Pennsylvania" in that amount.

(2) The Department will, within 30 days of receipt of a complete renewal form, mail or deliver to the applicant approval or denial of the requested renewal, or a request for additional information. If the Department denies the renewal it will provide written notice of the basis for denial. A renewed certificate will be valid for the period described in subsection (j).

(l) *Continuing education requirement.* As a prerequisite to renewal of certification under subsection (k), an affiliated qualified inspector shall attend at least 24 hours of relevant Department-approved continuing education training in the area of safe amusement ride and attraction erection and operation during the period of certification. A general qualified inspector shall attend at least 48 hours of this training during the period of certification. If a qualified inspector fails to comply with this continuing education requirement, certification will expire as of the expiration date on the qualified inspector's current certificate and credential card. If the Department determines that amusement rides or amusement attractions belonging to a particular category established under subsection (b) are of a comparatively simple design or operation to reasonably justify a requirement of fewer hours of continuing education for qualified inspectors of that particular category of amusement ride or amusement attraction than are otherwise required under this subsection, it may establish this continuing education requirement by publishing notice of this requirement in the *Pennsylvania Bulletin*, posting notice of this requirement on its web site and providing all qualified inspectors for the subject category of amusement ride or amusement attraction with written notice of this requirement. This reduced continuing education requirement may not entail less than 16 hours of continuing education training.

(m) *Revocation or suspension of certification.* The Department may revoke the certification of a qualified inspector for cause, after providing the qualified inspector written notice and opportunity for a hearing. A revocation will be for a specific period of time determined by the Department. The circumstances justifying revocation include the following:

- (1) Allowing another person to conduct an amusement ride or amusement attraction inspection under authority of the certificate or credential card.
- (2) Issuing an inspection affidavit without first conducting a thorough inspection of the amusement ride or amusement attraction that is the subject of the inspection affidavit.
- (3) Issuing an inspection affidavit with respect to an amusement ride or amusement attraction that does not meet the requirements of the act and this chapter.
- (4) Representing a qualified inspector to be an employee or agent of the Department.
- (5) Inspecting an amusement ride or amusement attraction that is not in the category of amusement ride or amusement attraction with respect to which the qualified inspector is certified.
- (6) Basing an inspection fee amount upon whether an inspection affidavit is issued with respect to the amusement ride or amusement attraction inspected.
- (7) Altering or defacing a certificate or credential card for the purpose of obscuring or misrepresenting the information on either document.
- (8) Other violations of the act or this chapter.

**Source**

The provisions of this § 139.9 amended December 12, 2008, effective December 13, 2008, 38 Pa.B. 6843. Immediately preceding text appears at serial pages (276966) to (276967).

**§ 139.10. Advisory Board.**

- (a) The Board is established under authority of the act, to exercise the powers and perform the duties ascribed to it in the act. The Board is appointed by the Governor, and consists of ten members, as follows:
  - (1) A representative of the amusement ride manufacturers.
  - (2) Two representatives of the Pennsylvania State Showmen's Association.
  - (3) Two representatives of the Pennsylvania Amusement Park Association.
  - (4) A representative of the Pennsylvania State Association of County Fairs.
  - (5) A mechanical engineer.
  - (6) Two public representatives.
  - (7) The Secretary or a designee, who will be designated by the Governor as the Chairperson.
- (b) The Board will hold public hearings at a time and place that the Board specifies to carry out its responsibilities.

**Source**

The provisions of this § 139.10 amended December 12, 2008, effective December 13, 2008, 38 Pa.B. 6843. Immediately preceding text appears at serial pages (276967) to (276968).

**§ 139.11. Accident reporting.**

(a) *Report required.* An owner or lessee shall file an accident report with the Department with respect to any accident which results in death or serious injury or illness as a result of the operation of an amusement ride or amusement attraction. The accident report form shall be faxed or delivered to the Department, at the address or fax number in § 139.14 (relating to contacting the Department), within 48 hours after the owner, lessee or operator is aware of the death, serious injury or illness. The reporting requirement described in this subsection applies from the time the owner or lessee acquires knowledge that such a death has occurred, or that the injury or illness is a serious injury or illness, as that term is defined in § 139.2 (relating to definitions) and section 2 of the act (4 P. S. § 402).

(b) *Accident report form.* An accident report required under the act and this section shall be made on a form provided by the Department. The accident report form may be downloaded from the Department's web site, or a supply of accident report forms may be obtained from the Department by request directed to the Department in accordance with § 139.14. The following information shall be included in an accident report:

- (1) The name and address of the operator of the amusement ride or amusement attraction at which the death or serious injury or illness occurred.
- (2) The name and address of the owner or lessee of the amusement ride or amusement attraction at which the death or serious injury or illness occurred.
- (3) A description of the ride involved, including registration number, name of ride, manufacturer and manufacturer's serial number.
- (4) A detailed description of the incident giving rise to the death or serious injury or illness.
- (5) The name and address of the dead, ill or injured person.
- (6) A general summary of the apparent illness or injuries sustained by each dead, ill or injured person.
- (7) The names and addresses of all known witnesses to the incident giving rise to the death, illness or injury.
- (8) The signature of the owner or lessee, verifying the accuracy of the injury report form subject to the penalties of 18 Pa.C.S. § 4904 (relating to unsworn falsification to authorities).

(c) *Duty of owner, lessee or operator to close ride or attraction pending inspection.*

- (1) When a death, a serious injury or illness or a fire occurs as a result of an operation of an amusement ride or amusement attraction, the owner, operator or lessee shall immediately close the ride or attraction until it has been inspected and declared safe by a qualified inspector.
- (2) If the serious injury described in paragraph (1) results in death, dismemberment, significant disfigurement or permanent loss of the use of a body

organ, the required inspection shall be performed by a qualified inspector who is an employee of the Department, and the ride or attraction may not be reopened until it has been inspected and approved to reopen, in writing, by the Department.

(3) If the serious injury described in paragraph (1) results in death, the ride or attraction may not be reopened until the written approval described in paragraph (2) is obtained and the ride or attraction is declared safe by the insurance company of the owner. This declaration shall be by writing delivered to the Department.

#### Source

The provisions of this § 139.11 amended December 12, 2008, effective December 13, 2008, 38 Pa.B. 6843. Immediately preceding text appears at serial page (276968).

#### Cross References

This section cited in 7 Pa. Code § 139a.57 (relating to site operating manual).

### § 139.12. Variances.

(a) *Application.* An affected owner or lessee of amusement rides or attractions may apply in writing to the Department for an order for a variance from any rule, regulation or standard.

(b) *Exceptions.* The Secretary may grant exceptions from the rules, regulations and standards adopted by the Department under the act if one of the following applies:

- (1) It is evident that the action is necessary to prevent undue hardship.
- (2) Existing conditions prevent practical compliance and reasonable safety of the public can, in the opinion of the Secretary, be assured.

#### Source

The provisions of this § 139.12 amended December 12, 2008, effective December 13, 2008, 38 Pa.B. 6843. Immediately preceding text appears at serial page (276968).

### § 139.13. Penalties.

(a) *Civil penalties.*

(1) A person who willfully or repeatedly violates the act or this chapter is subject to a civil penalty not to exceed \$2,000 with respect to each violation.

(2) If the Department elects to pursue a civil penalty, it will provide the person who is the proposed subject of that civil penalty with written notice of the proposed adjudication assessing the civil penalty, and afford that person 7 working days from receipt of that notice within which to deliver to the Department a written request for an administrative hearing on the proposed civil penalty.

(3) A written request for an administrative hearing must specify those portions of the proposed adjudication with respect to which the person requesting

the hearing takes issue, the basis for the objection and other relevant facts or arguments not addressed in the proposed adjudication. The administrative hearing will be limited to these objections, additional facts or arguments. Any portion of the proposed adjudication that is not specifically objected to will be deemed admitted at the administrative hearing.

(4) The Department will, in accordance with section 11(a) of the act (4 P. S. § 411(a)), grant an administrative hearing within 7 days of receiving a written request for an administrative hearing. The Department will grant this hearing by mailing or delivering a notice to the person making the request, setting forth the date, time and location of the administrative hearing. An administrative hearing is “granted” for purposes of section 11(a) of the act if the referenced notice is mailed or delivered within the 7-day period, regardless of whether the actual scheduled date of the administrative hearing is before or after the expiration of the referenced 7-day period.

(5) If a timely request for an administrative hearing is not received, the Department will issue the proposed adjudication as its final adjudication, and deliver that final adjudication to the subject of that document.

(b) *Criminal penalties.* An owner or lessee of an amusement ride or amusement attraction who willfully violates the act or this chapter where the violation causes death to a member of the public exposed to the violation, commits a misdemeanor of the third degree and shall, upon conviction, be sentenced to pay a fine not exceeding \$2,500 or to a term of imprisonment not exceeding 1 year, or both. If the conviction is for a violation committed after a first conviction, the offender shall be sentenced to pay a fine not exceeding \$5,000 or to a term of imprisonment not exceeding 1 year, or both.

(c) *False representation.* A person who knowingly makes a false statement, representation or certification in an application, record, report, plan or other document filed or required to be maintained under the act commits a misdemeanor of the third degree and shall, upon conviction, be sentenced to pay a fine not exceeding \$2,500 or to a term of imprisonment not exceeding 6 months, or both.

#### Source

The provisions of this § 139.13 amended December 12, 2008, effective December 13, 2008, 38 Pa.B. 6843. Immediately preceding text appears at serial pages (276968) to (276969).

### § 139.14. Contacting the Department.

(a) *Methods of contact.* For purposes of the act and this chapter, the Department may be contacted as follows:

- (1) By mail to the following address:  
Pennsylvania Department of Agriculture  
ATTN: Bureau of Ride and Measurement Standards

139-21

(339849) No. 411 Feb. 09

2301 North Cameron Street  
Harrisburg, PA 17110-9408

- (2) By telephone to (717) 787-2291.
- (3) By fax to (717) 783-4158.
- (4) By e-mail to: ra-amusementrides@state.pa.us.

(b) *Obtaining forms.* Forms and documents referenced in this chapter may be obtained by mailing, faxing or telephoning a request to the Department, or may be available from the Department's web site, at: [www.agriculture.state.pa.us](http://www.agriculture.state.pa.us)

(c) *Filing documents with the Department.* A document required to be filed with the Department under this chapter will be considered "filed" as of the date of postmark, fax transmission, e-mail delivery or actual delivery, whichever occurs first.

(d) *Delivering documents to the Department.* A document required to be delivered to the Department under this chapter will be considered "delivered" as of the date it is received at the Department, whether by mail delivery, e-mail, personal delivery, facsimile transmission or other electronic means.

#### Source

The provisions of this § 139.14 adopted December 12, 2008, effective December 13, 2008, 38 Pa.B. 6843.

#### Cross References

This section cited in 7 Pa. Code § 139.4 (relating to registration); 7 Pa. Code § 139.5 (relating to insurance); 7 Pa. Code § 139.6 (relating to itinerary); 7 Pa. Code § 139.8 (relating to inspection affidavits); and 7 Pa. Code § 139.11 (relating to accident reporting).

### Subchapter B. DESIGN AND CONSTRUCTION

- Sec.  
139.41. General.  
139.42. Structures.  
139.43. Passenger-carrying rides.

#### § 139.41. General.

(a) *Design and construction.* Manufacturers and fabricators of amusement rides and attractions shall design and construct the amusement rides, devices and structures to carry all loads safely and to withstand normal stresses to which they may be subjected. Structural materials and construction of rides and attractions must conform to recognized engineering practices, procedures, standards and specifications. This information shall also be furnished by the owner or operator for existing rides and attractions if required by the Department. Stress analysis and other data pertinent to the design, structure, factors of safety or performance characteristics shall be in accordance with accepted engineering practices.

139-22

(339850) No. 411 Feb. 09

Copyright © 2009 Commonwealth of Pennsylvania



(b) *ASTM International F-24 Committee Standards.* Manufacturers and fabricators of amusement rides and attractions shall comply with current ASTM International F-24 Committee Standards concerning amusement rides and devices as they pertain to manufacturer responsibilities for equipment design, testing, erection, operation maintenance and inspections. These ASTM International F-24 Committee Standards and subsequent amendments are incorporated by reference.

(c) *Changes or modifications.*

(1) The applicable standards shall be the ASTM International F-24 Committee Standards in effect as of the earlier of the following:

(i) The date of contract for original manufacture of the amusement ride or attraction.

(ii) The date of the bill of sale from the manufacturer to the original purchaser of the amusement ride or attraction.

(2) Any changes or modifications to the ASTM International F-24 Committee Standards after the earlier of the dates described in paragraph (1)(i) and (ii) may not apply to the amusement ride or amusement attraction unless the standards themselves require retroactive implementation or the Department makes adherence to these new standards a condition of registration.

(d) An amusement ride or amusement attraction shall operate in strict accordance with the applicable ASTM International Standards. If the attraction is modified the latest version of the ASTM International Standards shall apply to the change, alteration or modifications.

(e) Owners of existing amusement rides and attractions are responsible for obtaining the required construction maintenance and operational information from the manufacturer if available.

#### Source

The provisions of this § 139.41 amended December 12, 2008, effective December 13, 2008, 38 Pa.B. 6843. Immediately preceding text appears at serial page (276969).

#### Cross References

This section cited in 7 Pa. Code § 139.43 (relating to passenger-carrying rides).

### § 139.42. Structures.

Permanent buildings, enclosed structures that are not manufactured as part of an amusement ride or amusement attraction but that are nevertheless used for or as an amusement ride or amusement attraction shall be constructed to conform to the Pennsylvania Construction Code Act unless exempted under that statute or its attendant regulations, and shall have posted therein a certificate of occupancy issued by a building code official in accordance with the Pennsylvania Construction Code Act.

139-23

(339851) No. 411 Feb. 09

**Source**

The provisions of this § 139.42 amended December 12, 2008, effective December 13, 2008, 38 Pa.B. 6843. Immediately preceding text appears at serial pages (276969) to (276970).

**§ 139.43. Passenger-carrying rides.**

Amusement rides and amusement attractions shall be designed for safe operation and meet applicable ASTM International Standards, as described in § 139.41(c) (relating to general), and conform to the other requirements of this section to the extent they do not conflict with applicable ASTM International Standards.

(1) *Interior and exterior parts.* The interior and exterior parts of passenger-carrying amusement rides with which a passenger may come in contact shall be smooth and rounded, free from sharp, rough or splintered edges and corners, with no protruding studs, bolts, screws or other projections which might cause injury.

(2) *Padding.* Interior parts upon which a passenger may be forcibly thrown by the action of the ride shall be adequately padded.

(3) *Restraining devices.* Rides equipped with a safety bar, cage or other mechanically operated restraining device shall be equipped with a retiring cam or other device so designed that the safety bar, cage or other mechanically operated device cannot be inadvertently released.

(4) *Self-powered rides.* Rides which are self-powered and which are operated by a passenger shall have the driving mechanism and any moving part that might pose a threat to the rider guarded and the guards secured in place to prevent passengers from gaining access to the mechanism.

(5) *Safe entrance, exit and support.* Belts, bars, footrests and other equipment as may be necessary for safe entrance and exit and for support while the ride is in operation shall be provided. The equipment and the fastenings must be of sufficient strength to retain the passengers.

(6) *Passenger restraints.* Passenger restraining or containing devices used on tubs, cars, chairs, seats, gondolas and other carriers on a ride where the forces generated by the action of the ride require retention, restraining or actual physical support of the passenger shall be designed, constructed and installed where deemed necessary by the manufacturer to support the passenger safely. The fastening must be of a type which cannot be inadvertently released.

(7) *Anchorage.* Anchorages for the required restraining devices must have strength at least equal to the strength of the restraining device.

(8) *Travel clearance.* The path of travel of an amusement ride must have a clearance envelope that meets ASTM International Standards for patron clearance envelopes, to ensure that a passenger on the ride cannot be injured by contacting a structural member or other fixed or moveable object when the passenger is in the riding position in accordance with the manufacturer's specifications.

(9) *Emergency brakes and antirollback devices.* Emergency brakes and antirollback devices must be in accordance with manufacturer's specifications and, if required or recommended by the manufacturer, must be in place and operational when the ride is open for use by the public.

(i) If cars or other components of an amusement ride are subject to collide upon failure to normal controls, emergency brakes sufficient to prevent collisions shall be provided.

(ii) On rides which make use of inclined tracks, automatic antirollback devices shall be installed to prevent backward movement of the passenger-carrying units in case of failure of the propelling mechanism, unless movement in the reverse direction would not cause injury or damage.

(10) *Speed-limiting device.* An amusement ride capable of exceeding its maximum safe operating speed shall be provided with a maximum speed-limiting device.

(11) *Signal systems.*

(i) Signal systems for the starting and stopping of amusement rides shall be provided where the operator of the ride does not have a clear view of the point at which passengers are loaded and unloaded, or where the ride operator does not have a clear view of oncoming or returning passenger-carrying vehicles with sufficient line-of-sight to prevent a collision. A signal system must be a mechanical, electronic or other system that meets or exceeds the manufacturer's recommendations.

(ii) A code of signals adopted for the operation of an amusement ride shall be printed and kept posted at both the operator's station and the signalman's station. A person who may use these signals shall be adequately instructed in their use.

(iii) Signals for the movement or operation of an amusement ride shall be printed and kept posted at both the operator's and signalman's stations. A person who may use these signals shall be carefully instructed in their use.

(12) *Protection against moving parts.*

(i) An amusement ride may not be used or operated while a person is located in a position where a person would be endangered by the amusement ride. Areas in which persons may be endangered must be fenced, barricaded or otherwise guarded against public intrusion.

(ii) A ride containing or having a mounting that could entangle a passenger's hair must be guarded to minimize the risk of entanglement in accordance with manufacturer's specifications.

(iii) Machinery used in or with an amusement ride must be enclosed, barricaded or otherwise effectively guarded against accidental contact. Guards removed for maintenance purposes shall be replaced before normal operation is resumed.

(13) *Amusement ride and attraction ancillary equipment.*

(i) *Air compressors and hydraulic equipment.*

(A) Air compressors, air compressor tanks and appurtenances used in connection therewith shall be designed, constructed, equipped and maintained to insure safe operation.

(B) Air compressor tanks and other receivers used in connection with air compressors must comply with 34 Pa. Code Chapter 3a (relating to boilers and unfired pressure vessels).

(C) Air compressor tanks and other air receivers used in connection with air compressors must have the maximum allowable working pressure conspicuously marked thereon.

(ii) *Oil and hydraulic systems.*

(A) Oil and hydraulic systems and related equipment used in connection with amusement rides and attractions must be free of leaks and maintained to insure safe operations. These systems must have a dumping or by-pass valve that shall be drilled and sealed at 125% of working pressure by the manufacturer. Pressure gauges must have the maximum safe working pressures conspicuously marked thereon. Systems must have a manual lowering valve.

(B) Flexible hoses must have a bursting strength sufficient to withstand eight times working pressure and be tested at a pressure at least four times working pressure. They must be compatible with the fluid used therein.

(iii) *Internal combustion engine power sources.*

(A) Internal combustion engine power sources must be of adequate type design and capacity to handle the design load.

(B) Refueling of fuel tanks shall be performed only when the ride or attraction is closed down and unloaded and the engine is not running.

(C) When the engine is in an enclosed area, adequate ventilation shall be provided and the engine exhaust shall discharge to the outside.

**Source**

The provisions of this § 139.43 adopted December 12, 2008, effective December 13, 2008, 38 Pa.B. 6843. Immediately preceding text appears at serial pages (276970) and (316827) to (316828).

**Cross References**

This section cited in 7 Pa. Code § 139.71 (relating to general requirement).

**Subchapter C. OPERATION, MAINTENANCE AND RECORDS**

Sec.

- 139.71. General requirement.
- 139.72. Erection/disassembly of amusement rides and attractions.
- 139.73. Electrical system and equipment.
- 139.74. Temporary wiring.
- 139.75. Fire protection and prevention.

139-26

- 139.76. Ride and attraction operators and attendants.
- 139.77. Maintenance of amusement rides and attractions.
- 139.78. Rebuilt and modified rides.
- 139.79. Records.

### § 139.71. General requirement.

(a) Owners and operators of amusement rides, devices and structures shall conform to the ASTM International F-24 Committee Standards in effect as of the date the amusement ride or amusement attraction is registered with the Department, as they pertain to owner/lessee/operator responsibilities for equipment erection, testing, operation, maintenance and inspection. Changes or modifications to the ASTM International F-24 Committee Standards after this registration date may not apply to the amusement ride or amusement attraction unless the standards themselves require retroactive implementation or the Department makes adherence to these new standards a condition of registration.

(b) An amusement ride or amusement attraction must be constructed, maintained and operated in strict accordance with the applicable ASTM International F-24 Committee Standards. If the attraction is modified, the latest version of the ASTM International F-24 Committee Standards apply to the change, alteration or modification. If the modification is a major modification, the owner, operator or manufacturer shall also comply with § 139.78 (relating to rebuilt and modified rides).

(c) Air compressors and hydraulic equipment shall be inspected under § 139.43(13) (relating to passenger-carrying rides).

#### Source

The provisions of this § 139.71 amended December 12, 2008, effective December 13, 2008, 38 Pa.B. 6843. Immediately preceding text appears at serial page (276973).

### § 139.72. Erection/disassembly of amusement rides and attractions.

The owner or lessee shall cause each amusement ride, device or attraction to be erected in accordance with the manufacturer's recommendations as provided for in ASTM International F-24 Committee Standards, and conform to the other requirements of this section to the extent they do not conflict with applicable ASTM International Standards.

(1) *Lighting.* Amusement rides, access thereto, and means of egress therefrom shall, while in operation or occupied, be provided with illumination by natural or artificial means sufficient to guard against injuries to the public.

(2) *Proximity to high voltage lines.* Amusement rides must be located at least 15 feet from suspended high voltage lines carrying greater than 600 volts, or as otherwise defined in the *National Electrical Code*.

(3) *Ride entry and discharge.* Safe and adequate means of normal entry and normal discharge from each ride shall be provided.

139-27

(339855) No. 411 Feb. 09

- (i) At least two unrestricted means of egress remote from each other shall be provided from each floor, tier, room or balcony in structures which house amusement rides.
- (ii) Access to the means of egress shall be marked by readily visible signs in all cases where it is not immediately visible to the passengers.
- (iii) A means of egress must be at least 36 inches in width.
- (iv) The width of a stairway shall be taken as the length of the treads between stringers. The width of a doorway shall be taken as the width of the door.
- (v) The maximum travel distance from the most remote point in a room or enclosed space to an exit may not be greater than the following:
  - (A) One hundred fifty feet in unsprinklered construction.
  - (B) Two hundred feet in sprinklered construction.
  - (C) Seventy-five feet in dead ends.
- (vi) Means of access and egress must have protection from adjacent hazards and protection from falling by use of rails, enclosures or similar means.
- (vii) Means of access and egress must be free from debris, obstructions, projections and slipping, tripping and other hazards.
- (viii) The head clearance in passageways may not be less than 7 feet.
- (ix) Means of access or egress must have either stairways or ramps and connecting landings or platforms where the public enter or leave an amusement ride that is above or below grade.
- (x) Stairways, passageways, ramps, landings or platforms must be at least 36 inches in width for single lane passage or 44 inches for double lane passage. Landings or platforms must be at least 3 feet long measured in the direction of travel.
- (xi) Stair treads must be at least 9 inches deep, exclusive of nosing, and the rise may not exceed 8 inches. Between two connecting levels, the treads must be uniform depth and the risers must be of uniform height. The slope of ramps may not exceed one in ten except when nonslip surfaces are provided.
- (xii) Handrails must be provided on both sides of all stairways of four or more risers connecting adjoining levels whose difference in elevation is 30 inches or more.
- (xiii) Handrails must be at least 30 inches and no more than 34 inches above the surface of step treads and 42 inches above the landings, platforms, runways and ramps which are 4 feet or more in height or are adjacent to dangerous equipment or areas over deep water.
- (xiv) The distances between handrails may not be less than 18 inches for single lane passage and 36 inches for a double lane passage.

(xv) One intermediate rail spaced equal distance from handrail and base or equivalent construction to prevent a passenger from falling through the handrails shall be provided with all handrails.

(xvi) Stairways and ramps requiring handrails which are more than 8 feet wide shall be provided with railings dividing the widths into not more than 8 feet, and not less than 22 inches in width.

**Source**

The provisions of this § 139.72 amended December 12, 2008, effective December 13, 2008, 38 Pa.B. 6843. Immediately preceding text appears at serial pages (276973) to (276974).

**§ 139.73. Electrical system and equipment.**

(a) Amusement rides and attractions where restoration of electrical power could create a hazard shall be provided with a magnetic disconnect switch.

(b) An electrically operated amusement ride not designed to be controlled by the passenger shall be provided with an emergency stop switch placed within easy reach of the operator. A second back up—dead man, timer or safety switch, wired in series with the primary start/stop switch, shall be added to kiddie rides to provide added safety from unauthorized starting of the device. The safety switch shall be deenergized at the end of each ride cycle by the operator.

(c) Where electrical distribution and transmission lines have not been deenergized or where special insulating barriers to prevent physical contact with the lines have not been erected, a person shall be designated to give timely warning for all maneuvers of equipment, ride structures and machinery operated proximate to the lines so that ample clearance is maintained.

(d) Electrical wiring and equipment located outdoors shall be of a quality and constructed or protected that exposure to weather will not interfere with its normal operation.

(e) Electrical transformer stations must be properly enclosed and proper warning signs shall be posted.

(f) Outlets of more than 120 volts must be clearly marked to show their voltage.

(g) Services shall be installed in conformance with Article 525 of the *National Electrical Code*.

(h) Temporary electrical power and lighting installation shall be permitted during periods of construction, remodeling or demolition activities. Temporary electrical power and lighting shall be permitted for a period not to exceed 90 days when associated with operating amusement rides or attractions.

**Source**

The provisions of this § 139.73 amended December 12, 2008, effective December 13, 2008, 38 Pa.B. 6843. Immediately preceding text appears at serial pages (276974) to (276975).

**§ 139.74. Temporary wiring.**

(a) Feeders must be provided with overcurrent protection in accordance with the load imposed and conductor size as specified in Article 240 of the *National Electrical Code*.

(b) Branch circuits must originate in an approved power outlet or panelboard. Conductors shall be permitted within multiconductors. Conductors shall be protected by overcurrent devices at their rated capacity.

(c) Receptacles must be of the grounding type. Unless installed in a complete metallic raceway, branch circuits must contain a separate equipment grounding conductor and all receptacles must be electrically connected to the grounding conductor.

(d) Bare conductors or earth returns may not be used for the wiring of a temporary circuit.

(e) Suitable disconnecting switches or plug connectors shall be installed to permit the disconnection of ungrounded conductors of a temporary circuit.

(f) Lamps for general illumination exclusive of decorative or festoon lighting shall be protected from accidental contact or breakage. Protection shall be provided by elevation of at least 7 feet from a normal working surface or by a suitable fixture or lamp-holder with a guard.

(g) Temporary wiring over 600 volts shall be permitted during periods of construction, tests, experiment or emergency. A less permanent class of wiring and equipment shall be permitted than would be required for permanent installations.

(h) Suitable fencing, barriers or other effective means shall be provided to prevent access of other than authorized and qualified personnel to temporary wiring over 600 volts.

(i) Temporary wiring over 600 volts shall be removed immediately upon completion of construction or purpose for which the wiring was installed.

(j) Temporary electric wiring, if suspended, shall be supported so that its protective insulation will not be damaged.

(k) Overcurrent protection devices may not be installed in neutral or grounding conductors.

(l) Where electrical power is supplied for an amusement ride by a generating system, the generator and equipment must be properly grounded.

(m) Receptacles and attachment plugs must be of the grounding type and have ground fault interrupter (GFI) protection.

(n) Electrical installations and each electrically powered amusement ride must be effective as to noncurrent carrying metal parts which may become energized and which are exposed to contact by personnel. The path to ground from circuits, equipment and conductor enclosures must:

- (1) Be permanent and continuous.



- (2) Have ample carrying capacity to conduct currents liable to be imposed on it.
- (3) Have impedance, as evidenced by testing, sufficiently low to limit the potential above ground and to facilitate the operation of the overcurrent devices in the circuit.
- (o) Grounding which does not have a resistance to ground of 25 ohms or less as evidenced by testing shall be augmented by additional electrodes as needed spaced not less than 6 feet apart.
- (p) Temporary electrical lines placed at ground level must be of the “S” or equivalent type and be adequately insulated and protected in areas of vehicular or pedestrian traffic to provide the maximum public safety.

**Source**

The provisions of this § 139.74 amended December 12, 2008, effective December 13, 2008, 38 Pa.B. 6843. Immediately preceding text appears at serial pages (276975) to (276976).

**§ 139.75. Fire protection and prevention.**

- (a) Approved U. L. fire extinguishers shall be provided at gasoline-driven rides and otherwise where necessary to secure reasonable and adequate protection from fire hazards. Fire extinguishers shall be placed to be accessed and in use within 20 seconds of a person spotting a fire, and shall be sufficiently removed or protected from highly-flammable or exploding material to prevent their damage or destruction in the initial explosion or flames.
- (b) Flammable waste, such as oily rags or other flammable materials, shall be placed in covered metal containers which shall be kept in easily accessible locations. The containers may not be kept at or near exits.
- (c) Gasoline and other flammable liquids and flammable gases when stored shall be kept in reasonably cool and ventilated places. The liquids shall be in approved containers. Smoking and the carrying of lighted cigars, cigarettes, or pipes is prohibited in an area where liquids or gases are stored or are transferred from one container to another.
- (d) Fabrics constituting part of an amusement ride must:
  - (1) Conform to the following requirements, based on tests conducted in accordance with ASTM-E-84, or its current successor document:
    - (i) Flame spread rating of 0 to 75.
    - (ii) Smoke development of 0 to 450.
  - (2) Conform to the requirement of vertical burn test as follows:
    - (i) The average burn length may not exceed 8 inches.
    - (ii) The average flame time after removal of the flame source may not exceed 15 seconds.
    - (iii) Drippings from the test specimen may not continue to flame for more than 15 seconds.

(e) All parts of amusement rides and attractions shall be maintained in a clean condition.

**Source**

The provisions of this § 139.75 amended December 12, 2008, effective December 13, 2008, 38 Pa.B. 6843. Immediately preceding text appears at serial pages (276976) to (276977).

**§ 139.76. Ride and attraction operators and attendants.**

The ride operator shall operate the ride, device or attraction as follows:

- (1) The ride operator shall be at least 16 years of age as specified in the Child Labor Law (43 P. S. §§ 41—71).
- (2) On rides involving exposure to water to the extent that accidental drowning could occur, at least one person who is trained in life saving techniques shall be available on the premises at all times during operating hours.
- (3) The operator shall operate one ride at a time.
- (4) The operator may not operate a ride while under the influence of alcohol or drugs.
- (5) The operator shall be in the immediate vicinity of the operating controls during operation and no other person shall be permitted to handle the controls during normal operation. This paragraph does not apply to amusement rides designed to be operated or controlled safely by a passenger.
- (6) The number of operators and attendants shall meet or exceed the number of operators and attendants recommended by the manufacturer of the ride, device or attraction or the number prescribed in the ASTM International F-24 Committee Standards, whichever number is higher.

**Source**

The provisions of this § 139.76 amended December 12, 2008, effective December 13, 2008, 38 Pa.B. 6843. Immediately preceding text appears at serial page (276977).

**§ 139.77. Maintenance of amusement rides and attractions.**

(a) *Maintenance program.* The owner of an amusement ride or amusement attraction shall implement a program of maintenance, testing and inspection, based on manufacturer's recommendations, providing for the duties and responsibilities necessary in the care of each amusement ride or attraction. The maintenance program must include a checklist to be made available to the person performing the regularly scheduled maintenance. The maintenance program must include, the ASTM International F-24 Committee Standards for the operation, maintenance, testing and inspections.

(b) *Electricity lock-out.* A person performing maintenance or repairs, or making an inspection, shall lock-out the electrical disconnect switch when restoration of electrical power to an amusement ride or amusement attraction could create a hazard to persons during the performance of maintenance, repair, inspection or an

emergency evacuation of persons, and ensure that it remains locked out until restoration of power will not create a hazard.

(c) *Identification and rating plates.* Manufacturers' identification information affixed to the ride or attraction shall be maintained in a readily visible and legible condition at all times to the inspector.

(d) *Wire rope.*

(1) Wire rope shall be thoroughly examined. Wire rope found to be damaged shall be replaced with a new rope of proper design and capacity as set forth on the manufacturer's date tag. If failure of the rope would affect safety of the ride or attraction and its passengers any of the following conditions will be cause for rope replacement:

(i) In running ropes, six randomly distributed broken wires in a rope lay, or four broken wires in one strand of a rope lay. A rope lay is the length along the rope in which one stand makes a complete revolution around the rope.

(ii) In pendants or standing ropes—ropes bearing the entire load and subject to constant pressure and surge shocks—evidence of more than one broken wire in one rope lay.

(iii) Abrasion, scrubbing or peening causing loss of more than 1/3 of the original diameter of the outside individual wires.

(iv) Severe corrosion.

(v) Kinking, crushing, birdcaging or other damage resulting in distortion of the rope structure.

(vi) Heat damage.

(vii) Reduction from nominal diameter of more than 6.0%. Marked reduction in diameter indicates deterioration of the core resulting in lack of proper support for the load carrying strands. Excessive rope stretch or elongation may be an indication of internal deterioration.

(viii) Bird-caging or other distortion resulting in some members of the rope structure carrying more load than others.

(ix) Noticeable rusting or development of broken wires in the vicinity of attachments. If the condition is localized in an operating rope, the section in question can be eliminated by making new attachment. This may be done rather than replacing the entire rope.

(2) Wire ropes used to support, suspend, bear, or control forces and weights involved in the movement and utilization of tubs, cars, chairs, sets, other carriers, the sweeps, or other supporting members of a ride or attraction may not be lengthened or repaired by splicing.

(3) Mechanical devices that brake, control, or come in contact with wire rope, such as rollers, drums and sheaves shall be examined to ensure cleanliness and safe condition. Mechanical devices with broken chips, undue roughness or uneven wear shall be replaced immediately.

(e) *Wood components.* Footings, splices, uprights, track timbers, ledgers, sills, laps, bracing, flooring and all other wood components of rides, attractions and structures shall be inspected for deterioration, cracks or fractures. Emphasis shall be given to insuring tight nails, bolts, lag bolts and other fasteners. When wood piling requires replacement, ground level concrete piers shall be used. Wood members found to be defective shall be removed and replaced with material of equal or greater strength and capacity. Repairs and replacements to fixed roller coasters shall be made in accordance with the recommendations of the manufacturer.

(f) *Articulations and bearings.*

(1) The articulating pinions, frames, sweeps, eccentrics and other mechanical members shall be inspected for wear, out-of-round, cracks and other signs of deterioration, and shall be kept in good repair.

(2) Main center spindles shall be tested by nondestructive methods according to the manufacturer's specifications. Test results must list the date of the test, name of the ride owner and serial number or identification number of the device.

(3) Bearing surfaces, ball joints and other single or multiple direction mechanical surfaces shall be kept well lubricated, clean and inspected for out-of-round or out-of-spherical and shall be kept in good repair.

(4) Gear alignment and gear drives shall be kept in good repair.

(5) Motor wiring, general service circuitry, decorative wiring and festoon wiring shall be inspected for signs of deterioration such as cracking. Secure tape repairs may be used; however, use of tape repairs shall be kept to a minimum. Wire clips on articulating devices shall be kept in good repair, and particular attention shall be paid to wires at elbows and at the end of articulating devices during inspections.

(6) Retaining, restraining and containing devices shall be inspected to insure they can continuously fulfill their function. Worn and damaged areas shall be repaired immediately or be immediately replaced.

(7) The hydraulic system shall be checked for leaks, damaged pipes and worn or deteriorated hoses.

(8) A record of each inspection, test and maintenance shall be made immediately upon completion of the inspection/test and indicate those components subjected to special examination, such as X-ray, liquid penetrant, magnetic particle or ultrasonic testing and the dates the examinations were performed. The record must also include breakdowns or repairs and violations of this chapter with action taken to rectify the violation. The record shall be kept and made available to the Department and qualified inspector for at least 3 years.

#### Source

The provisions of this § 139.77 amended December 12, 2008, effective December 13, 2008, 38 Pa.B. 6843. Immediately preceding text appears at serial pages (276977) to (276979).

**§ 139.78. Rebuilt and modified rides.**

(a) *Major modifications.* An amusement ride which is subjected to major modifications shall be:

- (1) Re-identified by a different name or identification number, or both.
- (2) Subject to the act and this chapter as if it were a new ride not previously used.

(b) *Repairs.*

- (1) Repairs and replacement of materials shall be performed according to the requirements for new construction and as specified by the manufacturer.
- (2) Welding on amusement ride structural members and components shall be performed in accordance with American Welding Society (A.W.S.) Standards.

**§ 139.79. Records.**

(a) The owner or lessee of an amusement ride or amusement attraction shall maintain the following records onsite for 3 years, and make them available upon request of the Department, the Department's representative or the qualified inspector:

(1) *Daily inspection records.* Daily inspection records—including daily ride-specific inspection checklist records referenced in ASTM International F-24 Committee Standards—shall be prepared and maintained by the owner, lessee or operator who shall be experienced and knowledgeable in the proper assembly and operation of the ride or attraction. The inspection and tests must include operation of control devices, speed-limiting devices, brakes and other safety equipment. The inspection shall be made each day the ride or attraction is put into normal operation.

(2) *Tests.* Tests recommended by the manufacturer shall be recorded and a copy made available to the Department, the Department's representative and the qualified inspector. Evidence of satisfactory test results shall be recorded on a form or statement by one of the following:

- (i) The manufacturer of the ride or attraction.
- (ii) An insurance carrier lawfully doing business in this Commonwealth and carrying public liability insurance on the ride or attraction.
- (iii) A professional engineer.
- (iv) A person recommended by the manufacturer as qualified to perform the test.

(b) A complete maintenance and testing history file for each amusement ride and attraction shall be maintained at the ride or by the owner and be available to the Department or the qualified inspector.

**Source**

The provisions of this § 139.79 amended December 12, 2008, effective December 13, 2008, 38 Pa.B. 6843. Immediately preceding text appears at serial page (276980).

[Next page is 139a-1.]

139-36

(339864) No. 411 Feb. 09

*Copyright © 2009 Commonwealth of Pennsylvania*

## **Purpose**

The purpose of this booklet is to assist ride operators and attendants to do their jobs in a professional manner. To do so will lead to guests having a safe experience of amusement, pleasure, fun, excitement, or thrill, as intended through participation in our amusement rides and/or attractions.

As a ride operator or attendant, you play a key role in the success we achieve. Your appearance, courtesy, attitude, and professionalism in general will have a bearing on whether guests have a pleasant experience here and whether they will return for other visits in the future.

## **Guest Relations**

In addition to providing our guests with a smile, attentiveness, courtesy and a pleasing disposition, we are often called upon to think for them. It is important to keep in mind that, upon entering our gates, guests are seeking to leave behind their daily routine, replacing it for a while with a pleasurable, carefree existence. It is our duty to politely but firmly advise them when they are violating safety rules.

## **Environment**

Complementing our treatment of guests is the physical environment, which we provide them. If our guests' reaction to us is to be positive, we must surround ourselves with a clean, litter-free environment. Moreover, trash, litter, grease, and oil are safety hazards when allowed to accumulate in ride areas or anywhere on the grounds. A part of everyone's daily routine would be

*“A pick up to the environment by a pick of litter and trash”*

In summary, our philosophy becomes a reality when we bear in mind the equation:

Courtesy + Safety + Attitude + Cleanliness = Professional Operation

Of these factors, however there is no question of the foremost importance of one:

*“Take the extra step for safety!”*

## **Ride Operator and Ride Attendant Responsibilities**

It is the responsibility of all ride operators and attendants to insure an efficient ride operation by enforcing all regulations as well as those operating procedures dealing with the safe, efficient operation of the rides within your assigned ride group. The only difference between a ride operator and an attendant is a ride attendant may NOT operate the controls of a ride under provisions of the Child Labor Law Regulations of the

Commonwealth of Pennsylvania. Other than this difference, the responsibilities will be the same and will include, but may not be limited to the following:

1. Receive ride assignment from your supervisor and pick up the supplies needed for your ride.
2. Report to work at the proper time. Be ready for work when you report.
3. Make certain your personal appearance is in keeping with the accepted standards of company policy.
4. Sweep ride areas, wipe cars and ride seats and clean and/or polish cars, boats, or trains so the ride has an appearance that you would compliment.
5. Make a final test run of your ride before opening for the day to make sure everything is ready.
6. Check to be sure that everyone meets the admission requirements and height restrictions of your ride. When enforcing these restrictions, be tactful, courteous and consistent.
7. Conduct yourself in a responsible manner.
8. Be polite, treat your customers with the utmost courtesy.
9. Load the ride, directing guests to their seats making sure that proper load balances is maintained. Pay special attention to expectant mothers, guests with limbs in casts or braces, and guests showing the slightest sign of being under the influence of alcohol or drugs.
10. Help the guest of the proper riding instructions. Direct them while loading and unloading, providing assistance to any guests, young or old who may benefit from such assistance.
11. Inform the guests of the proper riding instructions. Direct them while loading and unloading, providing assistance to any guests, young or old who may benefit from such assistance.
12. Make your instructions audible, and in a courteous and friendly manner, as guests respond more favorably to a polite request than to a blatant command.
13. Position yourself at the ride as instructed and do not congregate at one area as this tends to distract your attention from the ride.
14. Operate the ride according to the instructions given during your orientation period and those given in your operating manual. Do not over speed your ride or increase the ride time. (Note: Ride attendants will not be operating the ride.)
15. Keep a watchful eye on the ride while it is in motion, never turning your back to the ride, never leaving your position or talking to passing friends while operating the ride. Closely observe the reaction of children who are riding.
16. Keep your work areas as clean as possible during the day.
17. Stay alert, safety-conscious and ready to act should any unusual situations occur.
18. Be prompt about returning from your break.
19. Maintain a positive attitude at all times. If there is a problem, discuss it with your supervisor.
20. Report any unusual activities or conduct to your supervisor IMMEDIATELY.



## Unusual Situations

Following is a list of unusual situations you may encounter and the procedures you should follow during these situations.

### 1. Mechanical

Although our ride mechanics thoroughly inspect our rides before each operating day, minor mechanical difficulties are bound to occur. Should this happen on your ride, immediately notify your Ride Supervisor who will inform you as to what procedure you should follow. The Ride Supervisor will close the ride, if necessary, until the problem can be rectified.

If, at any time, you hear any unusual noise or the ride does not appear to be running properly, close the ride and notify your Ride Supervisor immediately. Notify the guests waiting in line that the ride will be closing temporarily and will hopefully open again shortly. If you and your Supervisor anticipate a lengthy wait, please advise guests to return later in the day. Apologize for the inconvenience.

### 1. Weather

Weather conditions can interfere with your ride's normal operation. Some rides remain open during inclement weather; however, others must be closed for safety reasons. Your Ride Supervisor is aware of storm procedures and inclement weather operations. If your Ride Supervisor is not immediately available, and you have a question about continuing your ride operation in the inclement weather, please call the Rides Supervisor and ask about closing procedures. Generally, in heavy storms and heavy rain, all rides will close temporarily and reopen as soon as possible. Wait for clearance from a Ride Supervisor before reopening your ride.

### 2. Guest Complaints

Some of our guests may have problems or complaints, and you may be expected to handle these complaints. Remain courteous. Never argue with a guest. Attempt to answer the guest's complaint. If you don't know the answer, contact your Supervisor. Supervisors are always available to help with these situations. If the problem cannot be resolved, you should politely direct the guest to the office. More often than not, however, a complaint can be resolved simply by politely listening to the guest.

### 3. Injury to Guest/Employee or Damage to Equipment

Another unusual situation that may occur on your ride is an injury to a guest or employee, or damage to ride equipment. No matter how hard we try to prevent them, these incidents do occur. *Do not take these incidents lightly, and do not offer remarks concerning how the incident may have been avoided.* Remember to handle these situations professionally and in a confidential manner.

Remain calm and follow these 6 steps:

- a. Call Ride Supervisor.
- b. Give your name and exact location.
- c. Describe extent and nature of any injuries.
- d. Assist injured persons until First Aid arrives.
- e. Keep all spectators away from the scene.
- f. Do not make any comments or statements to anyone other than your supervisors or other persons authorized by the company.

#### 4. Handicapped Guests

During the course of your work, you will meet and deal with many different types of people. Of particular importance are our many handicapped guests, who may require special attention and some extra help at times. Handicapped guests may feel insulted or hurt by phrases such as, "Put the wheelchair over there". When dealing with handicapped guests, deal with the guest and not the handicap. They will appreciate your efforts.

It is our policy to give special treatment to handicapped guests. Our policy in Ride Operations is to treat them as VIP's extending to them a brand of courtesy and convenience beyond the norm. Whenever possible our operators should allow these VIP's to enter ride areas via ride exits if required, or extend whatever special assistance may be necessary in order to assure our handicapped guests of an extra measure of hospitality.

We set very high standards for all our ride operations. We expect you to be courteous to all of our guests while providing them with the safest possible rides. Remember, the safety of our guests is **IN YOUR HANDS**. An employee who is conscientious not only insures the safety of our guests, but also his own safety and that of his/her fellow operators. We expect you to provide our guests with the finest quality of service possible. Remember, you are in the business of providing entertainment for our guests. Go about your job in a positive frame of mind, complete your responsibilities as expected, and enjoy your role as one of the most important members of our staff – the operator or attendant of our amusement rides.

#### Ride Operator and Attendants General Rules

1. All employees must be in proper attire at all times when inside the ride areas. This includes the time involved in reporting to and leaving work.
2. Keep your ride "spic and span" at all times. Shine the cars and clean up excessive debris. If trashcans are full, notify your Supervisor.
3. Smoking, eating or drinking is not permitted on any ride; this applies to both the operator and the guests.
4. For safety reasons, all guests are required to wear shoes and shirts while riding.

5. No one except operators or maintenance personnel are allowed in work areas. Watch closely to see that guests do not wander into these areas.
6. Operators, in uniform, are not allowed on a ride at any time except during a test run before opening.
7. Pets of any description are not allowed on rides.
8. Do not permit any running or horseplay by guests while on a ride. Politely ask guests to walk to and from the ride.
9. Operators should watch closely for anyone throwing objects out of cars on the ride.
10. Always keep as many cars on the rides as needed in striving for safety and capacity, bearing in mind that proper load balances must be maintained.
11. Pay attention to all gauges on your ride for correct reading. Never run your ride faster than design speed. To do so, dramatically increases metal stresses and affects ride safety. If a discrepancy occurs, close the ride and contact your Supervisor.
12. While your ride is in motion, if a strange noise develops, shut the ride down immediately and contact your Supervisor.
13. Do not alter the audio level set by the ride foreman.
14. Do not overload your ride at anytime. When cars are designed for two people, never put a third person in.
15. Do not take cash for ride passage.
16. Speed your loading and unloading without forgetting all the safety factors involved. Before starting your ride, check all safety straps, chains, and bars to make sure they are fastened.
17. Watch the proper length of your ride. Increasing the time frequently has a negative, not a positive affect on riders.
18. Absolutely no loitering is permitted.
19. No smoking by anyone at or on the rides.
20. Do no sit on hand railings or ride fences.
21. Breakdowns must be reported whenever your ride is shut down during normal operating hours.  
Remain at your ride at all times, EXCEPT:
  - a. To report a ride breakdown (turn off controls, lock ride).
  - b. When taking an assigned break.
22. Be especially alert whenever small children are on your ride, as their actions are often sudden and unpredictable.
23. Off duty employees are not permitted up ride exits or, if riding, are not permitted extra rides.
24. At all times, WATCH YOUR RIDE.
25. At all times, USE COMMON SENSE.

## Your Attitude Matters

In today's world SAFETY AND ATTITUDE, are two words that need to be emphasized because they are important and affect our way of life. In exploring the meaning of the two words, SAFE means having escaped injury or damage; unharmed; free of doubt or error. ATTITUDE is a state of mind, behavior or conduct. These two words can affect almost every person, regardless of lifestyle.

Whether a person participates in a sporting event, labors at a trade or works in the amusement ride industry, job performance and quality of workmanship depend on the person's outlook and reflect on the performance of the job.

The difference between winning and losing a sporting event can depend upon a person's mental attitude. As for the operator, not only does his mental outlook decide his future, but is also affects the people who ride the machine his is operating. A bad attitude leads to poor workmanship, which could result in a malfunction and possible personal injury to the patron.

The amusement ride industry's role in handling and transporting people depends upon the operator and attendant's attitudes. Operating a ride in a safe manner protects the customer and could save a person from serious harm. The operator's role in transporting the patron certainly plays an important part; not only is he responsible for the patron, but his safe working habits and attitude can affect the safety of others as well as his own safety.

A safe attitude can play a BIG role in all our lives. By staying in the right frame of mind, we can accomplish all things we attempt in a safe manner.

Safe attitudes do protect lives. Think safe with a good attitude. Remember – your attitude matters.

## Skills Leaves Nothing to Change

A professional ride operator develops skills by learning all the characteristics of the machine his is operating.

1. Read the operation manual or pay close attention to the instructor.
2. Learn the sound and feel of the machine.
3. Learn what to do if there is a change in its sound or performance, such as shutting down the ride immediately and determining the causes or calling your Supervisor to determine the causes.
4. Know the maximum speed and loads of the ride and do not exceed them.
5. Be ready for work at call time.
6. Be polite and courteous to the patrons.
7. Observe the techniques of other professional operators. Remember skill leaves nothing to chance and neither does a professional operator. Do not

depend on luck; develop the knowledge and skills to be a professional operator.

### What Affects Your Job Performance

#### Alcohol

There is no doubt about it: Alcohol is the most abused drug in America today.

Drinking is involved in a large percent of all accidents in this state.

A lot of people have wrong ideas about alcohol. We'll mention three of them.

1. "Drinking alcohol increases efficiency". Alcohol is not a stimulant. It is a depressant. Alcohol hits you first in two places: in the brain (dulling your judgment) and in your reflexes (making them unreliable).
2. "If you've had too much to drink, coffee, milk or food will sober you." This is also a wrong notion. Only time will sober you. Alcohol leaves the body at the rate of about one ounce per hour. Once the alcohol is in your body there is nothing you can do to hurry the process.
3. "If you stick to beer or wine, you won't get drunk." Untrue, It's alcohol that causes the problem, not the form in which you take it whether liquor, wine or beer.

That old saying, "If you drink, don't drive" is still true. It is especially true if your livelihood depends on your ability to operate any machinery. If you are operating a ride while under the influence and have an accident, your troubles are multiplied and could very easily change the rest of your life...for the worse.

#### Drug

Americans use a lot of drugs; many of them are prescribed by physicians. Others are bought over the drugstore counter. There are medicines for colds, fatigue, tension, depression and many other conditions. Many of the drugs we take carry a warning that dizziness, drowsiness or sleepiness may be a side effect. We are warned not to drive a vehicle or operate machinery if any of these effects are present. Often we don't read labels and therefore we don't know the dangers. Medication can have effects that severely interfere with your ability to operate a ride.

Operating a ride is a full-time job. You need to be at your best: physically, mentally, and emotionally. Medications, both non-prescription and prescription, can be extremely dangerous. You may suffer side effects and therefore become less alert and less in control of your reflexes than you would be under normal circumstances.

It is especially dangerous to operate a ride when you mix drugs with alcohol or other drugs. If you take medications for such conditions as nervousness, being overweight, high blood pressure, hay fever and asthma, and then take only one ounce of alcohol, the

mixture of these can become many times more dangerous. They are dangerous enough by themselves.

Remember these things when you are getting ready to operate the ride. Don't endanger your own life and the lives of others by operating a ride when you are not at your best.

## Fatigue

Operating a ride is work. It is tiring. It takes specialized skills. A person must be in good physical, mental, and emotional condition to be a good operator. Many safety experts believe that an operator's mental and emotional state has something to do with almost every incident.

Most people think of a person being unfit to operate a ride when he or she has been drinking. But fatigue can be just as dangerous to an operator.

Extreme fatigue may lead to a dream state, or moment of dozing at the controls. Operating a ride under these conditions can be disastrous.

Boredom is common among ride operators, especially on days requiring long hours of operation. Your sense become dull, your eyes become fixed and you are not alert to situations around you. You may become "hypnotized" and unable to react. Before you know it, you can be involved in an incident. Inattention can kill or injure if you're operating a ride. It is important to keep your eyes moving – checking every aspect of the ride. If you feel boredom or fatigue slipping up on you, see if you can take a short break. At least, walk around and stretch your legs. This could save a life.

## Professional Operators Keep Their Cool

Amusement rides and operators responsibility may be taken for granted. For you, as a professional operator that's a dangerous practice.

When companies select ride operators, they consider the competence, dependability, mental, and physical fitness of the individuals. It is then up to you, the professional operators, to live up to the responsibility that is placed upon you. Professional operators must know how to operate the rides properly and safely and react correctly to every situation.

Professional operators check their machines thoroughly before starting them and report malfunctions immediately. Before and after each shift, professional operators check the brakes, controls, hoist, warning devices and lights.

Common hazards, such as co-workers working in the area, are known to the professional operators. They avoid quick starts and jerky stops, and bring rides to a complete stop before reversing direction or unlatching safety restraints for patron unloading.

Professional operators know the company rules and are also courteous. Professional operators know their machine and the conditions of the job. They have a sense of safety, operating the machines properly, efficiently and alertly. Professional operators know their jobs and perform them properly and effectively.

### Slips and Falls

A slip or loss of footing happens about as suddenly as anything you can imagine. It comes totally unexpected – a complete surprise – and the fall that follows is just as sudden. A slip and fall can happen almost any place and can be caused by a number of things – like spilled liquid on a deck or platform on which you suddenly step and away you go.

Be careful. Watch your step. Be alert to possible causes of slips and falls for yourself and the patrons. We don't want anyone hurt.

### Protect Yourself – Prevent Fires

Fire can destroy your job, your income and even you life. Fires can be prevented. It's a fact that most fires are caused by poor housekeeping, poor judgment, carelessness, ignorance and failure to follow instructions.

Fire prevention is everybody's job. Don't be a litterbug. Don't smoke in "No Smoking" areas.

It's your job to see that you and your co-workers don't become litterbugs. Litter that piles up becomes a fire hazard. Throwing trash and litter under the ride is an act of poor housekeeping.

If a fire or emergency occurs. DO NOT PANIC – STAY CALM – follow the plan. Know where the fire extinguishers are located. Do you know the proper extinguisher for each type of fire? For example, don't use water type extinguisher for on electrical fires. Remember, direct your extinguisher or hose at the base of the fire. Keep low, out of the heat and make sure you always have a clear path to the exit. Your life comes first.

**Class A** Ordinary combustibles, such as fire burning in wood, cloth, paper, and rubbish, rags, shavings and packing materials.

**Class B** Flammable liquids and gases, such as fires fueled by gasoline, oil, grease, paint, and paint thinner, propane and others.

**Class C** Electrical equipment fires, occurring in motors, controls, wiring, or those caused by electrical current.

**Class D** Combustible metal fires, such as those caused by zirconium, lithium and sodium.

There are basically six types of fire extinguishers.

- Water
- Chemical foam
- Compressed gas
- Dry chemical
- Multipurpose dry chemical
- Dry powder

Water-type extinguishers include pump tanks, stored pressure or those propelled by cartridge. They work by cooling the fire: use on Class A fires only. Type 2 – chemical foam – smothers the fire with foam: used on Class A and B fires. Type 3 – compressed gas (carbon dioxide) works by smothering the fire with gas: this type can be used on Class B and C fires. Type 4 – dry chemical – (stored pressure or cartridge operated) smothers fires with a blanket of powder: use this on Class B and C fires. Type 5 is multipurpose dry chemical, which also works by smothering the fire with a blanket of powder: this extinguisher is the most versatile and can be used on Class A, B and C fires. Type 6, the dry powder type, is for different combustible metals and can be used on Class D fires. Check the extinguishers at your area. Are they the proper type? Are they checked regularly?

In conclusion, let's make a checklist to see if we are practicing fire prevention.

- Trash and litter – no unnecessary accumulation
- Housekeeping – rides and area neat and clean
- Fire Extinguishers – well-marked and the right types
- Hazardous materials – stored in designated area
- Exits – unobstructed
- Wiring – Good connections, good grounds
- Smoking – only in designated areas
- Equipment – keep clean and use properly
- Flammable materials – handle with care
- Evacuation plan – practice – know your exit

### Child Labor Laws

Scheduling of ride personnel under the age of 18 if they have not graduated from high school must be done in compliance with the regulations set down by the Commonwealth of Pennsylvania. Supervisors and Group Supervisors should thoroughly familiarize themselves with these:



During School Term:

<u>Ages</u>	<u>Hours of Employment</u>	<u>Night Work</u>
15	May work only three (3) hours per day and total of 18 hours per week.*	Employment prohibited before 7:00 am and after 7:00 pm
*Note: The 18 hours may include eight (8) hours on Saturday and/or Sunday.		
16 & 17	May work only 28 hours per school week (Monday thru Friday) plus eight (8) additional hours on Saturday and/or Sunday.	Employment prohibited after 12:00 after 12:00 am with exception of Friday and Saturday evenings – may work until 1:00 am.

A 17 year-old who has quit school is not governed by the above rules.

During School Vacation

15	Maximum 8 hours per day; 40 hours per week.	Employment prohibited Before 7:00 am or after 9:00 pm
16 & 17	Maximum 8 hours per day, 44 hours per week.	No night work limit

A 17-year-old who has quit school is not governed by the above rules, and a 17-year-old is not subject to these regulations if graduated from high school; but only if graduated prior to starting date of employment.

Maximum Employment: No more than six (6) consecutive days without a day off. 30-minute meal period required after 5 hours.

No minor is permitted to be place on any payroll until the employment certificate (work paper) is on file in the office.

The Child Labor Law prohibits you from working in the operation of power-drive machines if you are under the age of 16.

*Violation of these laws may result in sever fines.*

GENERAL INFORMATION

Ride Assignments

Once you have signed in with your Supervisor, please get to your assigned ride as soon as possible. When you arrive at your assigned ride, begin cleaning and preparing it for operation so everything is ready to go by the ride opening time.

## Ride Closing Procedure

At the end of each operating day, ALL rides must be turned off at the main circuit breaker or disconnect for that ride. The panel containing the main circuit breaker or the main disconnect must be locked. On some rides, maintenance will perform the closing procedures. If in doubt about who closes your ride, check with your Supervisor. Strict adherence to this procedure is mandatory.

## Property Damage

At times, guests will report damage to articles of clothing or personal property.

In these situations, give your complete attention to the guests and refer them to your Supervisor.

## Grooming and Personal Appearance

To ensure that all employee impressions on our guests are positive, appearance is important. It is every Supervisor's responsibility to enforce all policies pertaining to correct wardrobe attire and to enforce the grooming standard for all employees. Grooming guidelines for ride operators and ride attendants follow:

**HAIR** – Hair must be neatly trimmed and well-groomed.

**BEARDS AND MUSTACHES** – Male employees may wear neatly trimmed beards and/or mustaches, which **MUST** be mature at hire date. They should not be grown during season if you begin working without one.

**COSMETICS** – All should be conservative regarding amount and color.

**JEWELRY** – Personal jewelry like rings, watches, etc is acceptable.

## Serious Illness or Injury to a Guest of Employee

1. Remain calm – do not move any injured person unless absolutely necessary.
2. Assist injured persons until First Aid arrives.
3. Keep all spectators away from the scene. (If a decision is made to empty the queue, you can assist in this.)
4. Under no circumstances should you discuss the incident with anyone other than your Supervisor or other persons authorized by the company.
5. Never make comments, even in jest, regarding the cause of the accident.

## Loss of Area Lighting or Power

1. Reassure all guests and ask them to remain where they are until emergency lighting or power is restored.

2. Call the Ride Supervisor.
3. Assist guests exiting dark areas of the rides.
4. Remain at your work area unless otherwise directed by management or security.

#### Evacuation

1. In an orderly fashion, direct all persons to the nearest exit.
2. Secure and lock rides.
3. Leave the area immediately. Do not return to get any items.
4. Do not make comments or statements.
5. Follow the directions of management or security.

#### During Storms

Most summer storms tend to pass quickly. If you must leave your ride for shelter during the storm, you should return as soon as the bulk of the storm has passed. At this time, everyone can start to wipe and dry rides, pick up any debris in the ride area and prepare to open. **An operator should never reopen a ride without receiving clearance from maintenance or the ride supervisor.** While you are drying the rides, **DO NOT FORGET** about the guests waiting to ride. In a courteous manner, try to inform them of the probable opening time of the ride.

#### After the Storm

After an electrical storm with extreme wind and rain, maintenance will check all rides before any are to be operated. **DO NOT OPEN** or start a ride until maintenance has arrived. This may take some time so while you are waiting, please make sure your ride is wiped, the ride area is free of branches and debris, and patrons have been informed. If in doubt as to whether to open or not, please **CALL THE RIDE SUPERVISOR** and he will call the appropriate personnel to inquire about the ride.

#### Continuous Inclement Weather

##### Maintaining our Standards

Throughout this manual, three ideas have been stressed repeatedly – **SAFETY, COURTESY, AND CLEANLINESS.** These are key factors necessary to maintain our consistent quality of entertainment. Any action or appearance which might jeopardize the quality of our operation is unacceptable. If mistakes are made, our primary concern is to correct them. We need to know and encourage you to report an error if one is made. Attempting to conceal an error or mistake accomplishes nothing. In certain situations, however, an action by an employee may be in violation of company policy, and result in that employee being issued a verbal warning. Issuance of any type of warning is a serious matter, and may result in immediate dismissal or a “no rehire” status. While we will always deal with each situation and each person on an individual basis, certain actions will result

automatically in the issuance of some type of warning, because of the potential consequences of this type of action.

1. Receiving a guest complaint on an employee's PERSONAL conduct will result in a verbal warning, depending upon the severity of the incident.
2. Leaving a work location unattended, without instructions to do so, in anything but an emergency situation will result in a suspension or immediate dismissal, depending on the severity of the incident. All work positions are designed to accomplish specific tasks, and leaving a position unattended affects not only the quality, but also possibly the safety of a location.
3. Acting in an unsafe manner will result in a verbal warning and possible further action. It is totally unacceptable, no matter what the reason, to jeopardize the safety of other employees, guests, or company property.
4. Many of our guests may be uneasy about going on certain rides or attraction, because of their lack of knowledge of what they are and how they function. In these situations, guests should be reassured and calmed by the action and explanation of employees. Joking about the safety or dependability of any ride or attraction will result in a verbal warning or dismissal, depending upon the situation. A guest cannot be expected to know if an employee is joking or not. **ALL QUESTIONS REGARDING THE SAFETY OR DEPENDABILITY REGARDING THE SAFETY OR DEPENDABILITY OF A RIDE OR ATTRACTION ARE TO BE ANSWERED IN A PROFESSIONAL, COURTEOUS MANNER.**

We all want to have fun while working. We must never lose sight, however, of the fact that we are to do a job – namely to provide each of our guests with the highest quality of entertainment.

#### Finishing Touches

1. Always be aware of how your look and appear to our guests. Please do not slouch, prop your feet, or lean; and avoid talking at length or loudly with another operator about your social concerns.
2. Remember that our guests ALWAYS come first. You may never insult, argue, be discourteous or use profane language in the presence of our guests.
3. A SMILE is the most important part of your attire. Always smile and maintain a pleasant speaking voice when asking for cooperation from our guests. You will find it is much easier when you do not yell or scream.
4. When a ride shuts down, our guests do not need to know the technical problems, but should be informed of the possible waiting time. Someone from the ride should stand at the ride entrance to inform the guests and to offer possible alternatives if the wait will be lengthy. Alternatives would include going to another ride or show and returning later in the day when they see the ride in operation. It is always a good idea to overestimate ride downtime rather than to underestimate it.

5. During the day, try to keep the guest waiting area clean as possible by picking up large cups and paper. This can be done on the way to and from breaks. It makes for a more pleasant appearance to the ride.
6. If you do not know the answer to a guest's question or are unable to handle a situation or resolve a problem, tell the guest you will put him/her in contact with someone who can.
7. A basic rule to remember is this:

*PUT YOURSELF IN THE SHOES OF THE GUEST AT YOUR RIDE.  
DO YOU LIKE WHAT YOU SEE?*

### Receipt of Ride Operations Manual – Confirmation

Please Read:

I hereby acknowledge that I have received and read a copy of the Ride Operators Manual. I have agreed to abide by all company rules and regulations contained in the manual.

NAME (please print)	EMPLOYEE #
Employee Signature	Date

Your first few days are extremely important since proper training and effective communications will assist you in doing your job well and feeling positive about it. Please answer the following questions, as they are indicators of your progress. Thank You.

	Yes	No
A. Do you know who your supervisor is?	<input type="checkbox"/>	<input type="checkbox"/>
B. Do you know the chain of command?	<input type="checkbox"/>	<input type="checkbox"/>
C. Do you feel that you have been given an adequate? introduction and training for your job?	<input type="checkbox"/>	<input type="checkbox"/>

**Pennsylvania Department of Agriculture  
Bureau of Ride and Measurement Standards  
Inspector Application**

Paid \_\_\_\_\_ Check # \_\_\_\_\_ Date \_\_\_\_\_

Pass/Fail Date \_\_\_\_\_ Credits Earned \_\_\_\_\_

License Sent Date \_\_\_\_\_ Exp Date \_\_\_\_\_

**This Form and payment must be returned to:**

PA Department of Agriculture  
Bureau of Ride and Measurement Standards  
2301 North Cameron St, Harrisburg, PA 17110-9408  
Phone: (717) 787-2291 Fax: (717) 783-4158  
Email: [RA-amusementrides@pa.gov](mailto:RA-amusementrides@pa.gov)

Instructions: Type or print clearly in ink- **NO PENCIL**. Complete every applicable section on this application or it will be returned. Resumes are not considered a substitute for complete answers. Application must be signed and dated at the bottom of this form for consideration.

**A check or money order payable to the Commonwealth of PA in the amount of \$50 must accompany this application.**

**Certification:**       **New**       **Renewal**       **Additional Affiliation**

Last Name		First Name		MI
Mailing Address				
City		State	Zip	County
Date of Birth	Home Phone (    )	Work Phone (    )	Email	
Highest grade of school completed <input type="checkbox"/> High School Grad <input type="checkbox"/> Higher Level (indicate below) <input type="checkbox"/> Other (indicate below)				
Other schools or training (for example: trade, vocational, armed forces or business). Give for each: the name and location (city, state, zip code of school and dates attended)				
<b>Class of Certification applying for or renewing:</b> <input type="checkbox"/> Affiliated Qualified Inspector Level 1- All Equipment (24 hours - every 3 years) <input type="checkbox"/> Affiliated Qualified Inspector Level 2- All Equipment (24 hours - every 3 years) <input type="checkbox"/> General Qualified Inspector - All Equipment (48 hours - every 3 years)		<b>Limited Affiliated Certification (16 hours – every 3 years)</b> <input type="checkbox"/> Water Attractions <input type="checkbox"/> Inflatable Amusement Attractions <input type="checkbox"/> Go Carts & Bumper Boats <input type="checkbox"/> Extreme Sports <input type="checkbox"/> Walk-through Attractions <small>Please note: certification in more than one of these categories will classify you as an Affiliated Qualified Inspector Level 1 (24 hours - every 3 years).</small>		
Name of Affiliated Company for whom you will be inspecting				
Name and Address of affiliated inspector's employer			Dates employed (month & year)	Hours worked per week
Exact Title of your position		Name of immediate Supervisor		Supervisor Phone # (    )
What knowledge, training and experience do you possess that would qualify you for the inspector level you are applying for per <b>TITLE 7. AGRICULTURE. § 139.9. Qualified inspectors.</b> ( <a href="http://www.pacode.com/secure/data/007/chapter139/007_0139.pdf">http://www.pacode.com/secure/data/007/chapter139/007_0139.pdf</a> )				

**Certification**

I certify that there are no misrepresentations or false statements in this document. All representations in this application are made subject to the criminal penalties for unsworn falsification to authorities (Pennsylvania Crimes Code, 18 Pa. C.S.A. §4904) and 7 Pa Code §139.13 (c) which provides a person who knowingly makes any false statement, representation, or certification in any application, record, report, plan or other document filed or required to be maintained pursuant to this Act commits a misdemeanor of the third degree and shall, upon conviction, be sentenced to pay a fine not exceeding \$2,500 or to a term of imprisonment not exceeding six months, or both.

Print Name \_\_\_\_\_

Signature \_\_\_\_\_

Date \_\_\_\_\_

## INTRODUCTION TO THIS DOCUMENT

It is the intent of this study material to help the reader become a more valuable member of the amusement industry. It is anticipated that the reader intends to become a Certified Amusement Ride Inspector empowered to operate within the Commonwealth of Pennsylvania. Therefore, it is important for the reader to understand that the ability to become a Certified Ride Inspector rests on a combination of experience, mechanical aptitude, and testing ability. Because of the requirement for experience, **NOT ALL THE QUESTIONS ASKED IN THE CERIFICATION TEST ARE FOUND IN THIS STUDY MATERIAL.**

## RESPONSIBILITY OF THE CERTIFIED RIDE INSPECTOR

It is **critical** to remember that the inspector who signs the inspection affidavit is the person **responsible** for the information found on that report.

Each inspector is responsible to provide a signed inspection affidavit for the inspection of **all** of the rides he/she inspects.

Inspections conducted by a **team** of inspectors require that each team member submit an inspection affidavit for rides he/she inspected.

**Multiple** signers of an inspection affidavit will **void** the document; and require an appropriate inspection by an explanation to the Department of Agriculture.

## HISTORY OF THE ACT

In 1984 the Pennsylvania Legislature enacted and Governor Thornburg signed into law legislation “providing for the inspection of amusement rides and attractions; granting powers and imposing duties on the Department of Agriculture; creating the Amusement Ride Safety Advisory Board; and imposing civil and criminal penalties”. This (Act 1984-81) is known as “The Amusement Ride Inspection Act”.

This Act empowers the Department of Agriculture to develop and enforce regulations found in 7 Pa. Code, Chapter 139. It is the Act and the accompanying regulations that will dictate the actions of Certified Amusement Ride Inspectors.

## **NOTE**

It is important that the reader clearly understands that the Department recognizes two (2) levels (also known as classes) of amusement ride inspection expertise. It must be clearly understood that an inspector and or operator must be able to speak, read, and understand English to participate in this test.

### **CLASS 1**

This is the basic inspection level. A class 1 inspector is empowered to inspect non-complex amusement rides such as (Inflatables, Bumper Boats, Go-Karts, Play Ports, Water Slides) and any other ride or attraction so designated by the Department.

### **CLASS 2**

This is the advanced inspection level. This class requires a more complete understanding of a number of complex amusement ride systems and have the ability to communicate this knowledge to others. The required experience and skill are expected to be commiserate to the abilities of the student. A class 2 inspector is empowered to inspect all approved amusement rides and attractions in the commonwealth.

### **INSPECTOR IDENTITY CARD**

Upon the successful completion of the appropriate level of testing a successful applicant is presented with a photo ID card that denotes his/her class date of issuance, and date of expiration.

It is incumbent upon the applicant that he/she read and understands all the information provided to the student by the Department, this is to include, but not be limited to, the Act and the accompanying regulations, as well as any appropriate reporting forms and procedures and any other information provided in the study packet.

### **PENALTIES**

It is important that the applicant fully, clearly, and completely understand his/her responsibility with relation to Pennsylvania Department of Agriculture Amusement Ride Regulations 7 Pa. Code, Chapter 139, Section 13, Sub-Sections a, b and c with regard to penalties.



## WHAT IS AN INSPECITON

An inspection is a visual examination of a ride or attraction to identify, report, and eliminate any situation that poses a threat to the safety and well being of human life.

## WHY INSPECT

It is the **moral** and **legal** responsibility of every amusement ride operator to ensure safe premises. Inspections are a proven means to help ensure a safe show.

## VALUE OF INSPECTION

Hazards can be eliminated, damage to materials and equipment can be prevented, and inspection can assess the effectiveness of maintenance, housekeeping, and training.

Inspection data is critical to safety incident investigation.

Inspection programs provide on-the-job safety training to ride operators.

Inspection records provide a paper trail to management to monitor safety.

## TYPES OF INSPECTION

The only expectable inspection is one that meets or exceeds those functions dictated by the manufacture and Pennsylvania law.

## TIMEING OF INSPECTIONS

Pennsylvania law requires that a portable ride be inspected every time it is erected for operation and that every permanent ride be inspected at least once a month.

However, all ride owners operating in the commonwealth are encouraged to perform daily inspections and each inspection be properly documented.

## RESPONSIBILITY OF THE INSPECTOR

**It is critical to remember that the inspector who signs the inspection affidavit is the person responsible for the information found on that report.**

Each inspector is responsible to provide a signed inspection affidavit for the inspection of all of the rides he/she inspects.

Inspections conducted by a team of inspectors require each team member submit an inspection affidavit for the rides he/she inspected.

Multiple signers on an inspection affidavit will void the document; require an appropriate inspection and an explanation to the Department of Agriculture.

This information is provide to help the reader more fully understand the demands, requirements, and responsibilities of a Certified Amusement Ride Inspector in the Commonwealth of Pennsylvania.

Successful completion of Part 1 of the certification test authorizes inspection of only items such as: moonwalks, bumper cars, bumper boats, go-carts, live animal rides, Miniature trains, attractions and other similar devices. Successful completion of Part 1 and Part 2 of the certification test authorizes inspection of all rides.

It is paramount to insure **“IN PENNSYLVANIA RIDES ARE SAFE”!**

# GUIDELINES FOR RIDE INSPECITON

## LOCATION AND INSTALLATION:

### ***1. Free From Adjacent hazards and Interferences:***

All rides, walk through shows, and funhouses, should be located in such a manner that they do not physically interfere with other rides. Severe and even fatal accidents have occurred as a result of improperly placed rides.

Operating clearances should be carefully verified for each ride prior to passenger loading. Nearby utility poles, trees, buildings, and other structures may present interference to safe ride operation and their clearances should be verified. There shall be a six-foot clearance between rides. Particular attention should be paid to overhanging items such as lighting, power lines, telephone cables, overhead piping, guy wires, and anything which is apt to be a hazard to the safe operation of the ride. It should be noted, that power lines may increase their sag under conditions of hot weather and heavy current draw (after the initial inspection). Be sure to take this possibility into account when inspections are made.

Rides and fencing should be so located that it is impossible for a person to reach over the fence and grab the hand of a passenger reaching out of a carrier.

### ***2. In Level Position on Solid Ground or Pavement:***

Portable rides are intended for installation on solid ground or pavement. They are designed in such a manner that no special foundations are required. Many of them are trailer mounted and have outrigger supports to provide stability and to resist wind forces. Some have hydraulic or mechanical jacks to assist in installation and leveling. Some will require blocking to produce a satisfactory installation.

Assuming that the soil or pavement is adequate to provide ride support, it is desirable that the ride be approximately level after all adjustments are made. This can usually be done by sighting the ride from several directions.

A small hand level can be used to arrive at a more accurate determination. In general, the taller the ride the more need for accurate leveling.

### **3. Properly Blocked and Jacked:**

Every ride installation should be examined to determine that the blocking or jacks, which have been used, are doing their job and not presenting a hazard in themselves. Narrow blocking should be avoided since the blocking should spread the load over a larger area and not concentrate it. Excessively high blocking contributes to instability. Poorly placed blocking can contribute to instability and should not be permitted. Blocking should be placed at the points which the manufacturer has indicated as being proper. In the absence of specific information, the blocking should be placed under the obvious strong points of the main frame or outriggers of the ride. Blocking generally should not be placed at locations where the structure may be observed to move or bend on the blocking as the ride operates. The structure and blocking should be checked to assure that the structure is resting firmly on the blocking and that a suitable number of blocks have been used to properly support the ride structure.

If the ride is equipped with mechanical or hydraulic jacks, the inspection is simplified. The jacks should be examined to make sure that they are in good mechanical condition and being used properly. Check for missing parts such as the base plate on the end of the Jack screw or cylinder. If the original plate is missing and another plate or wood block has been substituted, make sure it is of adequate size to properly spread the load (as the original one did). It should be noted that hydraulic pressure can increase in the jack due to expansion when the jack is exposed to heat and direct sun rays. This increased pressure can cause the leveling jack to raise the ride off of the locking rings or support and create an unstable condition. This condition can be avoided if the needle valves and hand pump valve are opened to relieve pressure on the leveling jacks after the ride is leveled and otherwise supported. Whether the ride has been blocked, jacked, or a combination of the two achieve level conditions, the important thing is to be sure that the ride is not only level, but, also supported securely on the blocks or jacks.

In all cases, the ride structure, and the blocks or jacks, should finally be examined when the ride is running. This is in order to be sure the support is proper and nothing has been overlooked. On some rides, the rides frame tends to move relative to the blocking during the ride operation. For this reason, the ride should be examined periodically during its operation to assure it does not move off of the blocking. Blocking shall have the same width, length, and height. (e.g. Four Foot high requires 4' X 4' base)

#### 4. Properly Anchored, Braced and Guyed:

If a ride requires anchors, braces, or guy lines to produce a satisfactory installation, they should be properly installed before the ride is permitted to operate. Items such as the inflatable plastic pillows, (i.e., Moonwalk, etc.), need to be anchored securely in position as they tend to move around rather easily in operation. Stakes are commonly used in conjunction with lines from the pillow in a manner similar to staking a tent. In this situation, the installation should be examined to make sure that a sufficient number of stakes have been properly installed to secure the item in position. The stakes, particularly near the entrance, should not be installed in such a manner as to present a stumbling or tripping hazard. On hard pavements where it is difficult to drive stakes, concrete anchors (similar to boat anchors) or sandbags are sometimes used. These can be effective and should be permitted if they are of adequate weight and appear to satisfactorily restrain the pillow.

##### Leveling and blocking (portable models)

1. Inspect leveling and blocking at each set up and at the start of each day (rides erected in soft locations require more frequent inspection).
2. Inspect for proper cross blocking or crib blocking. Cross blocking distributes weight evenly.

*Always cross block  
Cross blocking distributes weight evenly.*

*Recommended blocking:  
3 X 12 X 36" and 3 X 12 X 24"  
unless otherwise noted.*

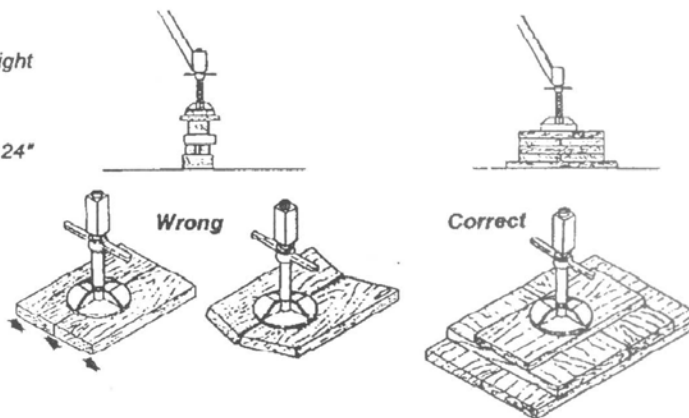

To avoid crushing under load "crib" blocking should be spaced no more than 1/4" for drainage.

*"Crib" blocking  
Large voids can let blocking crush under load. 1/4" spaces allow adequate drainage.*

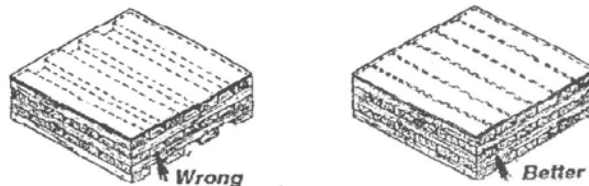

3. Inspect blocking for proper contact with ground

4. Level ground under blocking by digging where possible, instead of filling. Fill dirt will be soft and allow settling.

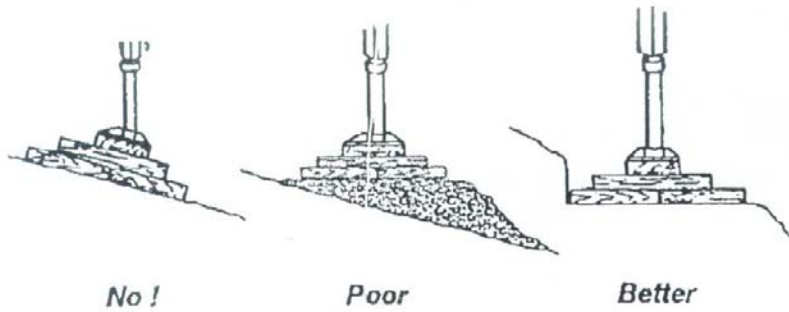

**Blocking on a slope**  
 Level the ground beneath blocking by digging where possible. Don't fill, the fill dirt will be soft allowing the ride to tilt

5. Inspect hydraulic leveling jacks for leaks at every set-up. The hydraulic jacks are for leveling purposes only. They must be retracted and their shut-off valves closed during normal ride operation. Likewise, they must be fully retracted and their shut-off valves closed before transporting the ride.

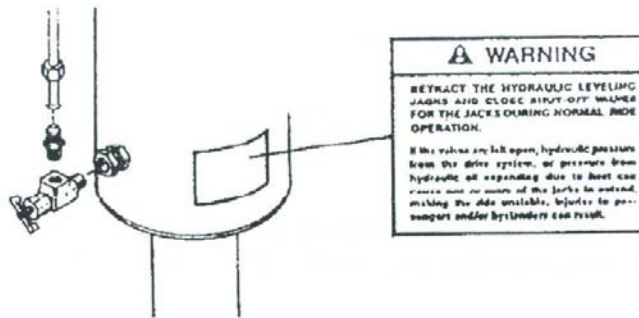

6. Check the lock rings on all screw jacks for tightness.

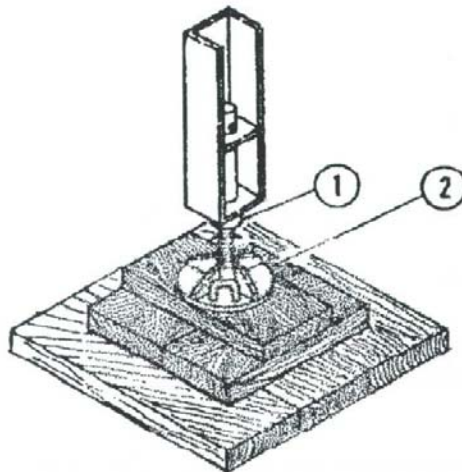

1. Screw jack
2. Lock ring

Bracing of a demountable nature is often used both on the ride structure and to support scenery panels. This bracing should be checked to verify it is present, installed at the proper locations, and adequately secured. A thorough visual examination of the ride will usually enable one to spot missing braces. Clues to look to for are holes not filled with bolts or pins. These may be intended as attachment points for braces. **In case of doubt, refer to the manufacturer's manual for definite information.**

Some rides, particularly high structures, use guy wires or cables to prevent collapse from wind loads or to tie various parts of the ride structure together more or less rigidly. Guy wires and wind braces, where necessary, should be properly placed, properly adjusted, and in good condition in order to accomplish their job. Connection points of all guy wires should be examined to be sure they are of good quality. If the connection is made to a stake in the ground, be sure that the stake is suitable anchored in the ground (or pavement) so it does not yield and allow the guy wire to develop excessive slack. Guy wires, many times, occur in pairs and when properly adjusted, will have nearly equal tension in both wires of the pair. If the wires are not properly adjusted, excessive movement of the ride may occur. The manufacturer's manual is a good reference to determine the number, placement and adjustment of the guy wires or cables.

#### ***5. Motors, Belts and Cables Guarded From Public:***

All rides should be checked to insure the machinery such as motors, belts, sheaves, engines, and similar items are effectively guarded or isolated from public contact. The guard or barrier should be such that it does not offer an accident hazard in itself. Guards should be fixed to the structure when possible, or secured elsewhere if attachment directly to the structure is not possible. In *no-case*, should the unguarded machinery be allowed to operate so as to endanger the public or to the ride operator.

#### ***6. Stairs and Walkways in safe and Secure Condition:***

Walkways should be solid and free of projections which might cause stumbling. Extremely smooth metal or wood surfaces can result from normal traffic wear. These can be conducive to falls and can be quite dangerous, particularly when wet. When these conditions are encountered, corrections should be made before operation is permitted. Handrails should be present on stairs and ramps. Walkways may or may not need handrails depending on the physical layout. The judgement and discretion of the inspector will be required in some cases to assess the degree of hazard involved and the correction to be made. Bear in mind that public safety is paramount. On rides

where the public enters or exits above grade, the stairs, ramps, and walkways should be checked to be sure they are in good condition.

## **7. *Proper Fencing and Railings***

All rides must be adequately fenced to provide protection to spectators and riders. Fences should be located to provide a safe distance from the outmost point of swings or aerial rides.

Breaks in fencing be limited to those necessary to allow proper entrance and exit by passengers. Slides, or their walkways, should be protected by guards to restrain the person sliding from falling over the side. Power units should be shielded from the public. In some cases, this will require fencing. Depending upon the construction of the power unit, however, some units can be shielded by barricades or screen panels at the openings of the trailer containing the power unit. **The inspector should use his judgement to determine that a proper result is being obtained.**

## **8. *Fuels Properly Stored and Free of Spills:***

Flammable liquids and liquid petroleum must be stored in approved safety containers. Storage of flammable liquids should not be permitted in any area accessible to the public. Under no circumstances should the fuel supply be replenished while the engine is running. Spills caused by overfilling or any other cause should be cleaned up prior to operation of the engine. Equipment with leaky pumps, tanks, and fuel lines, should not be permitted to operate until it is satisfactory repaired. Attention should be given to devices using liquefied petroleum gases (propane, etc.) to assure that they do not present a fuel storage or operating hazard.

## **9. *Fire Extinguishers- Number, Size & Locations:***

The Inspector should verify that a properly charged fire extinguisher is present on every site and that the operator knows its location. All extinguishers should meet the standards of state and local fire officials.

## **10. *Free of Unguarded Pinch Points:***

Rides and shows should be carefully examined for areas where a person might be struck by, caught in, caught between, or otherwise exposed to moving parts or hazards. Be alert to the possibility that children and even adults sometimes do unexpected things and thereby risk their own safety.



# STRUCTURAL INTEGRITY:

## ***11. Assembled in Correct Manner:***

A ride, when completely assembled, should be examined to determine if it has been put together properly. Previous experience and the manufacturer's manual will be of value in making this determination. Gross misassembled will be rather obvious by comparing the assembled ride with photos or drawings in the manual.

Some mis-assembly will be less obvious, such as a member being bolted to the wrong place or attached to the wrong side of another member.

Sometimes this can be determined by an examination of photos or sketches and sometimes it "**Just doesn't look right**". Any sign or clue of improper assembly should be reason not to allow the ride to operate until the correctness of the assembly has been determined. In case of doubt, contact the inspection office. The essence of correct assembly is the use of proper components in the right places. Be alert to areas which have been modified from the manufactured configuration. Mechanical items which you know or suspect to be different from the original item should be checked to determine if they appear adequate for the job. They should also be looked at from the standpoint of their effect upon the characteristic of the ride such as speed, control, braking, etc. If the substituted item has deteriorated the quality and safety of the ride, then its use should not be permitted.

## ***12. Free of Cracks and Excessive Wear:***

Most manufacturer's service manuals and bulletins will indicate the areas where heavy stresses occur and where cracks are prone to develop. The bulletins usually pin point specific areas where problems have been found and indicate the corrective action necessary. In some cases, modification kits are required to correct the problem. In other cases, instructions are given for making repairs on the existing members. It should be remembered information is not exhaustive and cracks or other problems may develop in areas for which there is no information available. If the repair is to be made by welding, it should be done by a welder skilled in this type of repair. If cracks are welded cracks structural members which show evidence of abuse, extensive welding, or wide spread cracking should be recommended for further repair. Poor quality welds can many times be detected by their appearance. In case of doubt, do not permit a ride with evidence of poor welding to operate until satisfactory correction has been made. In some cases, the manufacturer will indicate that a particular member is not to be repaired by welding. Any cases of this nature should be cause not to allow the ride to operate no matter how good the weld may appear to be. **Insist that**

**the repair be made in accordance with the manufacturer's specifications.**

Cracked paint may or may not indicate a cracked area. It is a good clue, however, and all such locations should be examined carefully. The areas around bolt and pin holes should be examined for cracks. Pins and bolts in critical areas should also be checked for evidence of cracks, particularly in the threaded portions, around cotter or pin holes and under the head. In case of doubt, have the bolt or pin replaced before operation.

During the examinations of the structure for cracks, the inspector should look for loosened bolts or rivets and badly worn or elongated holes. Pinned connections or other joints that have developed excessive wear should be recommended for repairs in accordance with manufacturer's specifications.

### ***13. Properly Pinned With Correct Grade of Bolts:***

Ride manufacturers use bolts throughout their products. Many in locations where failure could be catastrophic with injury or death resulting. Inspectors and others, concerned with ride safety, need to familiarize themselves with the various types and grades of bolts used by the ride industry. Identification of bolts that are in place on a structure should be of particular concern to inspectors and ride maintenance personnel. Rides built by European manufacturers will contain graded metric bolts. The inspector should check for loose bolts and also verify that common bolts have not been substituted for graded bolts. Particular attention should be given to the main ride structure, sweep connections, tub and car attachments, and nay connection where bolt failure could be catastrophic.

### ***14. Properly Pinned Secured with Retainers:***

As an aid to rapid assembly and disassembly, many ride connections are made with pull pins rather than bolts. The type of pin used is designed to be used with a spring pin ("R" pin or other type) as a retainer to prevent the pull pin from working our as the ride operates. These pins have strength qualities similar to graded bolts. The inspector should make sure that any pins which have developed cracks should be replaced. Spring retaining pins, ("R" pins), which have spread to the point that they are no longer held securely in position, should also be replaced.

### ***15. Properly Aligned Including Sheaves and Cables:***

A ride should be inspected for alignment of major parts such as uprights, wheels, bearings, sheaves, guides, couplings, cables, gearing, shafting and

other mechanical parts or assemblies. Most out of line conditions can be determined by visual inspection. In case of doubt, contact the inspection office.

## **16. Cables, Chains, Belts and Gearing in Safe Condition:**

All wire rope, whether used for support or drive cables or for any other purpose, must be thoroughly examined. Wire rope found to be damaged is to be repaired or replaced with new rope of proper design and capacity, in accordance with the ride manufacturer's specifications. Any of the following conditions is cause for rope replacement or repair:

- A. In running ropes, six randomly distributed wires in one rope lay, or three broken wires in one strand in one rope lay. A rope lay is the length along the rope in which one strand makes a complete revolution around the rope.
- B. In pendants or standing ropes (ropes bearing the entire load and subjected to constant pressure and surge shocks), evidence of more than one broken wire in one rope lay.
- C. Heat damage including welding, brazing and soldering to the rope itself.
- D. Improper use of Clamps and Excessive Splicing:

All mechanical devices that brake, control, or come in contact with wire rope, such as rollers, drums and sheaves must be examined for broken chips, undue roughness, uneven or extreme wear.

Chains, belts, gearing and other drive components should be checked to make sure that they are in satisfactory operating condition and show evidence of proper lubrication.

Support chains such as those used to support chair seats on swings should be examined to make sure they are in good condition and are attached safely. Extreme wear, cracked or broken links or attachments, call for immediate replacement. It is recommended that chain be welded link and of proper capacity; and any components shall be of compatible material. Check with Manufacturer for proper type of chain.

2. Severe stretching occurring in a short section of cable, indicated by a marked reduction in the diameter of the cable.

3. Severe physical damage such as kinking, crushing or "bird caging".



Kinking



Crushing



Bird Caging

4. One strand being 75% broken through.

5. A number of wires, equal to the number in a strand, broken in the length of one rope lay.

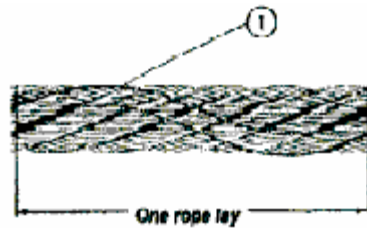

"Lay as a unit of measure  
1. One Strand

# WIRE ROPE

## SOCKETING

Improperly attached wire rope terminals lead to serious-possibly unsafe-conditions. To perform properly, all wire rope elements must be held securely by the terminal. If this is not accomplished, the strands will become "high". A high strand condition is illustrated in Figure 42. In the case shown, selective abrasive wear of the high strand will necessitate early removal of the rope.

### Poured Sockets-Spelter or Resin

When preparing a wire rope for socketing, it is of extreme importance to follow recommended procedures. (See Appendix D: SOCKETING PROCEDURES). Procedures other than those stipulated here, may develop the required strength but this cannot be pre-determined without destructive tests. It is far safer – and ultimately less costly – to follow well-established practices.

There are many ways to go wrong in socketing procedure. Some of the more common pitfalls that should be guarded against include:

- 1) Turning back the strands-inward or outward-before the "broom" is inserted into the socket.
- 2) Turning back the strands and seizing them to the body of the rope.
- 3) Turning back the strands and tucking them into the body of the rope.
- 4) Tying a knot in the rope;
- 5) Driving nails; spikes, bolts, and similar objects into the socket after the rope is in, so as to "jam" it tight; this is particularly dangerous-and ruinous.

*To avoid these and many other dangerous practices, play it safe by following correct procedures.*

## WIRE ROPE CLIPS

Wire rope clips are widely used for making end terminations. Clips are available in two basic designs; the U-bolt and fist grip (Fig. 23). The efficiency of both types is the same.

*When using U-bolt clips, extreme care must be exercised to make certain that they are attached correctly, i.e. the U-bolt must be applied so that the "U" section is in contact with the dead end of the rope (Fig. 24). Also, the tightening and re-tightening of the nuts must be accomplished as required.*

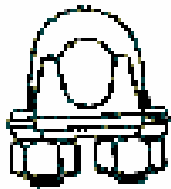

U-BOLT



FIST GRIP

## HOW TO APPLY CLIPS

U-BOLT CLIPS (Table 6, p. 31)

Recommended Method of Applying U-Bolt Clips to Get Maximum Holding Power of the Clip

- 1) Turn back the specified amount of rope from the thimble. Apply the first clip one base width from the dead end of the wire rope (U-bolt over dead end-live end rests in the clip saddle). Tighten nuts evenly to recommended torque.
- 2) Apply the next clip as near the loop as possible. Turn on nuts firm but do not tighten.
- 3) Space additional clips if required equally between the first two. Turn on nuts-take up rope slack-tighten all nuts evenly on all clips to recommended torque.

## WIRE ROPE

4) Notice! Apply the initial load and retighten nuts to the recommended torque. Rope will stretch and be reduced in diameter when loads are applied. Inspect periodically and retighten to recommended torque.

A termination made in accordance with the above instructions, and using the number of clips shown has an approximate 80% efficiency rating. This rating is based upon the nominal strength of wire rope. If a pulley is used in place of a thimble for turning back the rope, add one additional clip.

The number of clips shown also applies to right regular lay wire rope, 8 x 19 class, 6 x 19 class or 6 x 37 class, fiber core of IWRC, IPS or EIP. If Scale construction or similar large outer wire type construction in the 6 x 19 class is to be used for sizes 1 inch and larger, add one additional clip.

The number of clips shown also applies to right regular lay wire rope, 8 x 19 class, fiber core, IPS, sizes 1 1/2 inch and smaller; and right regular lay wire rope, 18 x 7 class, fiber core, IPS, or EIPS, sizes 1 3/4 inch and smaller.

For other classes of wire rope not mentioned above, it may be necessary to add additional clips to the number shown.

If a greater number of clips are used than shown in the table, the amount of rope turnback should be increased proportionately. ABOVE BASED ON USE OF CLIPS ON NEW ROPE.

**IMPORTANT:** Failure to make a termination in accordance with aforementioned instructions, or failure to periodically check and retighten to the recommended torque, will cause a reduction in efficiency rating.

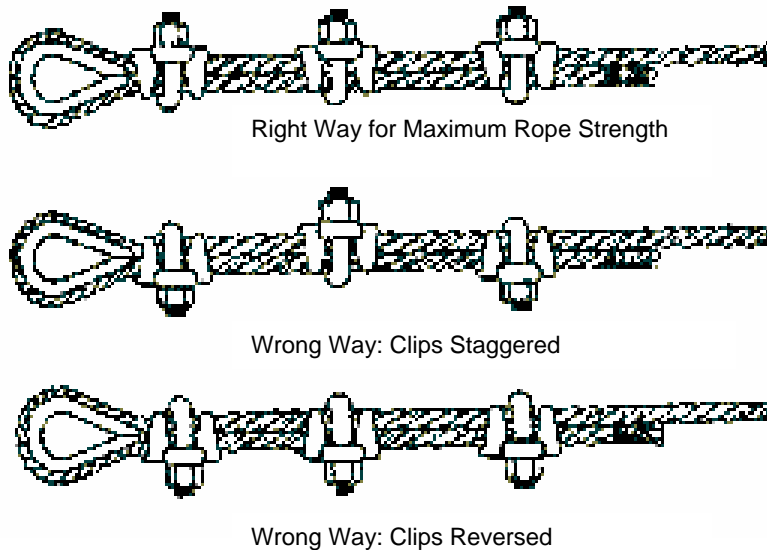

**Figure 24.** The *correct way* to attach “U” section is in contact with the rope’s dead end and is clear of the thimble.

## **FIST GRIP CLIPS**

### **RECOMMENDED METHOD FO APPLYING FIST GRIP CLIPS**

- 1) Turn back the specified amount of rope from the thimble. Apply the first clip one base width from the dead end of the wire rope. Tighten nuts evenly to recommended torque.
- 2) Apply the next clip as near the loop as possible. Turn on nuts firmly but do not tighten.
- 3) Space additional clips if required equally between the first two. Turn on nuts take up rope slack – tighten all nuts evenly on all clips to recommended torque.
- 4) **NOTICE!** Apply the initial load and retighten nuts to the recommended torque. Rope will stretch and be reduced in diameter when loads are applied. Inspect periodically and retighten to recommended torque.

A termination made in accordance with the above instructions, and using the number of clips shown has an approximate 80% efficiency rating. This rating is based upon the catalog breaking strength of wire rope. If a pulley is used in place of a thimble for turning back the rope, add one additional clip.

The number of clips shown is based upon using right regular or lang lay wire rope, 6 x 19 class or 6 x 37 class, fiber core or IWRC, IPS or EIPS. If Seals construction or similar large outer wire type construction in the 6 x 19 class is to be used for sizes 1 inch and larger, add one additional clip.

The number of clips shown also applies to right regular lay wire rope, 8 x 19 class, fiber core, IPS, sizes 1 ½ inch and similar; and right regular lay wire rope, 18x 17 class, fiber core, IPS or EIPS, sizes 1 ½ inch and smaller.

For other classes of wire rope not mentioned above, it may be necessary to add additional clips to the number shown.

If a greater number of clips are used than shown in the table, the amount of rope turnback should be increased proportionately. **ABOVE BASED ON USE OF FIST GRIP CLIPS ON NEW WIRE ROPE.**

***IMPORTANT:*** Failure to make a termination in accordance with aforementioned instructions, or failure to periodically check and retighten o the recommended torque, will cause a reduction in efficiency rating.

### **17. Motors Clutches and Controls Working Properly:**

Before ride start-up, all elements of the drive system should be examined to determine if they are complete and in apparent good condition. Operation, levers and handles, should be checked to determine that they are securely attached and operate freely without binding or interference. They should be inspected to determine that connections and pivots are properly pinned and retained. Adjusting devices such as turnbuckles, stop collars, adjusting screws, and the like, should be properly adjusted and held in place by appropriate means. All controls should be checked for normal and proper operation. Any control deficiencies or malfunctions indicated, must be repaired before the ride is allowed to operate with passengers.

### **18. Brakes and Stops in Good Condition:**

All brakes must be checked to determine that they are in apparently satisfactory mechanical or electrical condition, prior to operation. The brakes should be tested by the operator before loading passengers to be sure they function properly. Any indication of improper brake condition or action is cause not to allow the ride to operate, until the necessary corrections have been made. All Stops and anti-rollback devices must be checked and tested before operation to determine that they are in apparently satisfactory mechanical condition.

### **19. Hydraulic Systems in Good Condition:**

All hydraulic systems, concerned with ride operation, should be inspected to determine that they are functioning properly and safely. They should be free of leaks, damaged hoses, malfunctioning valves, or any condition that could result in detrimental ride operation. The system must contain a pressure relief valve and a properly functioning pressure gauge. Any condition causing oil mists or sprays must be corrected because of the high fire hazard which it presents. Accumulations of hydraulic oil from leaks should not be permitted.

### **20. Air Systems in Good Condition:**

The air compressors, tank equipment lines and controls, should be checked to verify that they are in good operating condition. They should be free of leaks, equipped with a pressure relief valve and a pressure gauge.

## **VEHICLE INTEGRITY**

### **21. Latches Operate Properly:**

All rides originally equipped with safety bar, lap bar, cage or other mechanical restraining device should be checked to determine that the device is still in place, and the hinges and latches align and operate properly and are in good condition. Passengers should not be permitted in any vehicle or carrier with defective latches until a satisfactory repair has been made. The inspector may permit the ride to operate, providing, the vehicle with defective latches are blocked off from carrying passengers, and, if the unloaded tubs are not otherwise detrimental to the safety of the ride.



## **22. *Properly Attached and Secured:***

All vehicles or passengers carrying devices should be inspected determine that they are properly and securely attached to the ride. Points to look for are proper pins and retainers, correct grade, size and length of bolts and the integrity of the tub, bolts, and ride structure at the points of attachment.

## **23. *Safety restraints Are Safety Anchored and Buckled:***

All rides originally equipped with seat belts, should be checked to verify that they are still in place and in satisfactory condition. Buckles should buckle securely. The attachment of the belts to the tub or structure should be of good quality and at least as strong as the belt or strap. Modification or substitution of other items in place of the original belts should be permitted if the substituted item is at least as good as the original. Any vehicle or carrier which does not have proper seat belts or other restrainers, should be blocked off until satisfactory restrainers are installed. The ride may be permitted to operate if the unloaded tubs are not otherwise detrimental to the safety of the ride.

## **24. *Back Up Latches Present and Functional:***

All back up latches on rides so equipped originally, must be present and in proper working order. All rides that were originally equipped with safety retainers to prevent a tub or carrier, which might become disengaged from its' support, from being thrown from the ride must have such retainers present and in satisfactory condition.

## **25. *Skin Free of Unrepaired Cracked and Damage:***

The inside and outside of all tubs and carriers that a passenger might come in contact with, should be checked to determine that surfaces are smooth, rounded and free from sharp, rough or splintered edges and corners, with no protruding studs, bolts, screws, nails or other projecting which cause injury. Skin surfaces should be free of unrepaired cracks and holes.

## **26. *Seat-Coverings in Safe Condition:***

The seat coverings and interior padding of all tubs or carriers are to be inspected both for condition and adequacy to prevent injury. Seat coverings should be kept in good repair and loose portions should not be permitted.

# ELECTRICAL SAFETY

## **27. Equipment Grounding:**

All portable rides, fun houses, generator trucks, office trailers, light towers, food concession stands, and game stands must properly grounded according to all applicable codes.

## **28. Transformers and Generators Guarded From Public:**

Diesel or gasoline engines driven power units must be located in a manner permitting proper maintenance and must be guarded by fencing or enclosures to prevent hazard to adjacent building or other combustible items. Warning signs must be posted.

## **29. Proper Insulation on Wires and Cables:**

No broken, frayed or bare wiring may be used. Any wiring repairs must be done to applicable codes.

## **30. Cables Properly Connected at Plugs and Boxes:**

All connections to moving portions of a ride must be connected so there is no tendency to pull the wire loose when the ride is operating.

## **31. Electrical Boxes Covers, Latches and Signs:**

Electrical junction boxes are to be secured during the time when the general public is in the area. The electrical boxes shall be at least six inches above ground level. The cover of the box must be such as to avoid the possibility of rain entering the box. Opening in the box must be such that the public does not have access to the inside of the box.

## **32. Switches and Controls Operate Properly:**

The inspector should observe the ride in operation with the operator using each control as he would when operating with a load of passengers. All controls must operate normally or the ride should not be permitted to run until abnormalities have been corrected. The operator should demonstrate the capability to make an emergency stop of the ride. Unless an emergency stop can be, and is, made in a timely manner, the ride should not be allowed to operate until this capability is provided.

Controls shall be “fail safe” so if the power goes off, no hazard is presented to the public (such as brake failures, etc). Controls must also be such that no hazard is presented by the ride on resumption of electric service following the loss of power. Resumption of ride operation must be under control of the operator following power interruptions.

### **33. *Lighting Securely Attached, Connected and Guarded:***

All lighting fixtures and bulbs should be checked to determine that they are securely connected. Shields should be provided and in place on all fluorescent tubes.

### **34. *Operating at Safe Speed (RPM):***

The inspector should determine the safe speed of the ride or device from the nameplate or the manufacturer’s manual. If this information is not available, report this fact to the inspection office. The inspector should check the speed at which the ride is being operated. If the speed is in excess of the Manufacturer’s rating, the ride shall not be permitted to operate with passengers until the condition has been corrected.

### **35. *Operating at safe Load (People):***

The inspector should determine the passenger capacity of the ride from the nameplate or the manufacturer’s manual. If this information is not available, report this fact to the inspection office. No ride shall be permitted to operate with passenger loads in excess of the rated capacity of the ride.

### **36. *Proper Loading and Unloading Practice:***

Each ride or device shall be operated by a competent operator trained for the duty. When the ride or device is shut down, provision must be made to prevent operation by the public. No person other than a trained operator shall be permitted to handle the controls of a ride or device during normal operation, except where it is designed to be controlled by the passenger. Ride entrances shall have a passenger waiting line, retaining bar, chain, rope, gate or other method effectively restraining entrance to the ride area. The layout of the ride should be such that the operator (or operators) can control the loading and unloading of passengers. Additional guidelines for operator are listed below.

## **MISCELLANEOUS SAFETY ITEMS**

### ***37. Rides Free of Loose Items:***

Moving parts of every ride should be checked to make sure that there are no loose items which might be thrown off as the ride is operated. This would include such things as covers, wrenches, bolts, nuts, beverage containers or any loose item which might become a hazard.

### ***38. Free of Hazard Projections:***

The entire area of the ride, including the ride proper, the controls, the fencing, entrances and exits should be examined to make sure that no hazardous projections which will result in or contribute to an incident.

### ***39. Proper Warning Signs:***

The outlets or terminal boxes of electrical power lines carrying more than 120 volts must be clearly marked to show their voltage. All power generators and transformers must have appropriate warning signs posted. Entrance and exit signs should be posted at the discretion of the inspector. All stored and flammable liquids shall be properly identified and marked with words such as "fuel", "gasoline", or "danger".

### ***40. Maintenance Log:***

The maintenance log should be kept current, (daily), and be at the location of the ride and available for inspection.

### ***41. Tubs/Sweeps Individually Numbered:***

This is to facilitate the inspection process by correlating data systemically between the inspectors and the operator.

### ***42. Records:***

Should be kept and available for inspection of:

- A) Maintenance
- B) Safety Inspections
- C) Operator Training

#### **43. Consistency:**

All hardware used should be consistent, i.e. don't mix "R" keys with cotter keys in the same application.

#### **44. Housekeeping:**

Areas around and under rides should be kept clear of debris and old parts.

# **Maintenance safety Guidelines – All Rides**

## **Preventive Maintenance**

Preventive maintenance is the best assurance for a successful operation. The ride operator should clean and inspect the ride daily. Lubrication should be performed at recommended intervals.

## **Maintenance - - First Two Weeks**

The ride has been completely serviced and tested before leaving the factory. However, during the first two weeks of operation, the ride operator should be especially observant and watch for possible oil leaks, etc. During the first two weeks, all bolts and nuts should be checked daily for tightness. After the first two weeks, they should be checked at least monthly.

## **Maintenance Safety Instructions**

1. All work must be done by competent, qualified mechanics capable of understanding the function of the parts and their proper installation and utilizing the service manual from the manufacturer.
2. Inspect the ride each day of operation to determine that no portion of the ride is damaged, omitted or worn in a manner that it is unsafe, or that unsafe conditions may develop.
3. Perform manufacturer's recommended maintenance procedures at intervals and in the manner specified by the ride manual, in the following general areas, including but not limited to:
  - A. Lubrication
  - B. Drive and Electrical Systems
  - C. Torquing of Bolts
  - D. Wear of Bolted or Pinned Joints
  - E. Adjustment and Care of Mechanical Components such as Brakes, Arms, Drive and Belts
  - F. Passenger Securing Devices
  - G. Crowd Control Devices
  - H. Operating and Emergency Controls
  - I. Factory-Installed Safety Devices
  - J. Blocking and Foundation

4. Ensure that only factory replacement parts are used. Use of any parts not meeting factory specifications shall void any and all warranties, guarantees, and liabilities related to damaged or failure caused by use of the parts.
5. Study each job carefully to determine all hazards so that necessary safeguards can be taken.
6. Examine safety devices, tools, ladders, etc., before they are used to make sure they are in good condition. Ladders should be clean and unpainted.
7. Use the proper tool or equipment for each job. Ground all held electric power tools before use.
8. Wear close-fitting comfortable clothing when working on or close to mechanical apparatus or live electrical circuits. Avoid finger rings, jewelry or other articles which may be caught in moving parts. Wear approved safety glasses and goggles.
9. Protect your eyes. Wear approved well fitting glasses or goggles.
10. Wear hard hats at all times an overhead hazard are present. Working in elevated areas, use a safety harness and follow fall arrest procedures.
11. Prior to any employee performing any servicing or maintenance activities where the expected energization, start-up or release of stored energy could cause injury, they should Lock or Tag Out and follow Lock/Tag Out Procedures.
12. Where work is performed hazardous, such as live electrical circuits, at least two people put it back up.
13. Make sure, if you remove any protective, guards, they are back in place before sure, if you remove guards, insure they are back in place before beginning the ride. If you removed the protective fence around the ride center, put it back up.
14. Clean up after each job. Dispose of surplus materials.
15. Keep a record of parts replaced and date of replacement. Inform manufacturer of any replacement requirements that are frequent found in an unsafe conditions.

16. Make modifications and additions as outlined in manufacturer's service and safety bulletins.

## **GENERAL MAINTENANCE – ALL RIDES**

### **TOUBLESHOOTING PROCEDURES**

Prior to calling for factory help on a ride having problems, certain things should be done ahead of time to eliminate wasted time by both parties.

1. Have ride serial number and name available.
2. Have manual ready to use as reference.
3. Have the same person make all calls and be sure to get name of person you are speaking to at the factory. All calls should then be made to that person.
4. Have telephone number ready that you want return calls made to.
5. Have shipping instructions ready to give, such as how, and when, and where to ship parts (no post office boxes).
6. Have list of any alterations, modifications or kits that ride may have.
7. Have a person make the call that is familiar with the problem and can describe symptoms of ride problems, such as, was the problem a gradual thing?, did it suddenly quit?, are any sounds occurring that are not normal?, does the problem occur continuously or is it intermittent?, does the ride run but has no braking?, etc.
8. Many times the problem that will completely stop a ride from working will be one of many simple things that are forgotten or overlooked when a person starts to look for what appears to be a major breakdown. Listed on the following chart are many of the items that may cause this, as well as items that should be checked before any calls are made to the factory. Check over this chart and determine if it could be any of them. It may save several expensive phone calls or a more expensive visit by a factory representative, as well as valuable time.



## **LOCK-OUT PROCEDURES**

To assure the safety of maintenance working on or about any large piece of equipment such as an amusement ride/attraction or device, lock-out procedures should be developed and implemented.

The following is an example of a typical maintenance lock-out procedure.

(Example:)

### **Lock-out procedure**

#### **Ride/Attraction:**

The main key switch of the control power must be locked in the off position and the key removed to avoid any accidental start-up of the device while personnel are working on it.

A red tag must be affixed to the emergency stop button before any maintenance work can be carried out on the ride or attraction.

#### **Maintenance:**

Employees working about moving machinery or live equipment and circuits shall proceed with great care when performing their work, considering carefully each act and doing nothing which may endanger themselves or others.

Employees shall be careful to place themselves in a safe and secure position and to avoid slipping, stumbling or moving backward into moving machinery or live parts, or into openings.

#### **Note:**

It is recommended that all power and operating machinery be locked off prior to any work being started, however where live electrical circuits and operating machinery is necessary to perform required work, a minimum of two (2) qualified persons should be required in these locations maintaining radio, or telephone communications to the ride/attraction control operator.

## LOCKOUT PROCEDURES

Whenever it becomes necessary to work on belting or any piece of machinery, employees shall assure themselves that a proper tag is attached to the pump, governor, valve throttle, switch, or other device used to set the machine into motion.

The equipment shall be de-energized and locked out. Each employee should be assigned one 6 hole "scissors-type" lock-out assembly, two personal padlocks (for which only the employee will have keys) and two plastic "Danger-do Not Operate" tags to be used in conjunction with the padlocks and lock-out device.

These lock-out tools must be carried by the employee to the job site at all times, and be properly installed before any work is performed on electrical or mechanical equipment whenever there is the possibility of electrical shock, or of the possibility of machinery being set in motion while work is being performed.

Each person working on the job must install a padlock and tag identified and employees name on the lock-out device before beginning to work and should remove the personalized lock and tag when leaving the job site.

If the machinery does not have a safety switch, or does not have a switch that can be locked off, notify the electrical department prior to beginning work.

The electrical crew will remove fuses or disconnect wires in order to make the job safe to perform the work.

Red-tagging where fuses are removed or wires disconnected must be done by the electrician and only the electrician can restore power by making the necessary connections.

Locking a push-button station stop button "off" shall not be considered as safety locked off, because a problem with the wiring or someone tampering with the motor starter could energize the equipment.

In a case where a circuit breaker is the only disconnecting means, in lieu of disconnecting wires, a "Do Not Operate" tag may be securely attached to the turned off breaker and a guard posted to assure that no one turns the circuit on.

No one may, at any time remove any other persons locking device, or start up any equipment while anyone else has it locked out.

## Penalties:

Persons found working on the equipment without proper lock out precautions should face severe disciplinary action, including the possibility of immediate discharge.

Person who remove other that their own lock-out devices or start a piece of equipment while locked out by another person, should be severely disciplined, including the possibly of immediate discharge.

## ASTM Standards

The Pennsylvania Amusement Ride Inspection Act, No 1984-81 as well as the Amusement Ride regulations for the Commonwealth of Pennsylvania refer to ASTM Standards. Just what are these standards and how do they apply to me?

ASTM stands for American Society of Testing Materials, an organization located in West Conshohocken, Pennsylvania that facilitates the writing of voluntary consensus standards. Several amusement industry groups, government , and public interest groups formed ASTM Committee F-24 on Amusement Rides and Device in 1978. These groups included the OABA ( Outdoor Amusement Business Association) , the IAAPA ( International Association of Amusement Business Parks and Attractions), Manufacturers, Suppliers, the CPSC (Consumer Product Safety Commission) and members of the Public.

ASTM Committee F-24 on Amusement Rides and Devices develops voluntary consensus standards for the amusement industry. ASTM standards are intended to be voluntary until such time as a government agency adopts the standards. **Pennsylvania has adopted ASTM F-24 Standards as a portion of their Rules and Regulations.**

The committee currently has eleven subcommittees: Testing Methods Specifications, Quality Assurance, Design and Manufacturer, Maintenance, Operations, Inspection, Water Related Attractions and Devices, Terminology, Public Relations and Long Range Planning.

ASTM F-24 Standards on Amusement Rides and Devices can be purchased from ASTM Headquarters in West Conshohocken, PA by calling (610) 832-9693. To receive the latest standards on F-24, order the Annual Book of ASTM Standards, Volume 15.07 on End Use Products. This annual compilation lists changes and additions made by Committee F-24 during the preceding year.

# NATIONAL ELECTRICAL CODE

## ARTICLE 525- CARNIVAL, CIRCUSES, FAIRS, & SIMILAR EVENTS

### A. General Requirements

525-1 This article covers the installation of portable wiring and equipment for carnivals, circuses, exhibitions, fairs, traveling attractions and similar functions, including wiring in or on all structures.

525-2 Other Articles.

- (a) Permanent Structures. Articles 518 and 520 shall apply to wiring in permanent structures.
- (b) Portable Wiring and Equipment. Whenever the requirement of other articles of the is Code and Article 525 differ, the requirements of Article 525 shall apply to the portable wiring and equipment.

525-6. **Protection of Electrical Equipment. Electrical equipment and wiring methods in or on rides, concessions or other units shall be provided with mechanical protection where such equipment wiring methods are subject to physical damage.**

### B. Installation

525-10 Power Sources.

- a) Separately Derived Systems.
  - (1) Guarding. Service equipment shall not be installed in a location that is accessible to unqualified persons, unless the equipment is lockable.
  - (2) Transformer. Transformers shall comply with applicable requirements of Section 230-3(a), (b)(3) and (c); Section 250-30; and Article 450.
- b) Service. Services shall be installed in accordance with applicable requirements of Article 230 and, in addition, shall not be installed in a location that is accessible to unqualified persons, unless the equipment is lockable.
  - (1) Guarding. Service equipment shall not be installed in a location that is accessible to unqualified persons, unless the equipment is lockable.
  - (2) Mounting and location. Service equipment shall be mounted on a solid backing and be installed to be protected from the weather unless of weatherproof construction.

Service equipment must be installed in accordance with Article 230 and must not be installed where accessible to unqualified person unless it is lockable. This includes service equipment connected to separately derived systems, such as generators.

#### 525-12. Overview Conductor Clearances.

- (a) Vertical Clearances. Conductors shall have a vertical clearance to ground in accordance with section 225-18. These clearances shall apply only to wiring instead outside of tents and concessions.
- (b) Clearance to Ride and Attractions. Amusement rides and amusement attractions shall be maintained not less than 15ft(4.57m) in any direction from overhead conductors operating at 600 volts or less, except for the conductors supplying the amusement ride or attraction. Amusement rides or attraction shall not be located under or within 15ft(4.57 m) horizontally of conductors operating in excess of 600 volts.

#### 523-13. Wiring Methods.

- (a) Type. Unless otherwise provided for in this article, wiring methods shall comply with the applicable requirements of Chapter 1 through 4 of this Code. Where flexible cords or cables are used and are not subject to physical damage, they shall be permitted to be listed for hard usage. When used outdoors, flexible cords and cables shall also be listed for wet locations and shall be sunlight resistant.
- (b) Single Conductor. Single conductor cable shall be permitted only in sizes No. 2 or larger.
- (c) Open Conductors. Open conductor are prohibited except as part of a listed assembly of festoon lighting installed in accordance with Article 255.
- (d) Splices. Flexible cords or cables shall be continuous without splices or tap between boxes or fittings. Cord connectors shall not be laid on the ground unless listed for wet locations. Connectors and cable connections shall not be placed in audience traffic paths or within areas accessible to public unless guarded.
- (e) Support. Wiring for an amusement ride, attraction, tent or similar structure shall not be supported by any other ride or structure unless specifically designed for the purpose.
- (f) Protection. Flexible cords or cables run on the ground, where accessible to the public, shall be covered with approved nonconductive mats. Cables and mats shall be arranged so as not to present a tripping hazard.
- (g) Inside Tents and Concessions. Electrical wiring for temporary lighting, where installed inside, and where subject to physical damage, shall be

provided with mechanical protection. All temporary lamps for general illumination shall be protected from accidental breakage by a suitable fixture or lampholder with a guard.

**525-14. Boxes and Fittings. A box or fitting shall be installed at each connection point, outlet, switchpoint, or junction point.**

**525-15. Portable Distribution or Termination Boxes. Portable distribution or termination boxes shall comply with (a) through (d).**

**(a)Construction.** Boxes shall be designed so that no live parts are exposed to accidental contact. Where installed outdoors the box shall be a weatherproof construction and mounted so that the bottom of the enclosure is not less than 6 in. (152mm) above ground.

Portable distribution or termination equipment must be mounted so that the bottom of the enclosure is at least 6 in. above ground. This prevents excessive moisture from entering the equipment and allows for proper radius of bend on conductors entering and exiting the equipment form below.

**(b)Busbars and Terminals.** Busbars shall an have ampere rating not less than the overcurrent device supplying the feeder supply the box. Where conductors terminate directly on busbar, busbar connectors shall be provided.

**(c)Receptacles and Overcurrent Protection.** Receptacles shall have overcurrent protection installed within the box. The overcurrent protection shall not exceed the ampere rating of the receptacle, except as permitted in Article 430 for motor loads.

**(d)Single-Pole Connectors.** Where single-pole connectors are used, they shall comply with section 530-2.

**525-16. Overcurrent Protection.** Overcurrent protection of equipment and conductors shall be provided in accordance with Article 240.

**525-17. Motors.** Motors and associated equipment shall be installed in accordance with Article 240.

**525-18. Ground-Fault Circuit – Interrupter Protection for Personnel.**

**(a) General-Use 15- and 20-ampere, 125-Volt Receptacles.** All 125-volt, single-phase, 15 and 20-ampere receptacle outlet that are in use by personnel shall have listed ground-fault circuit-interrupter protection for personnel. The ground-fault circuits-interrupter shall be permitted to be an integral part of the attachment plug or located in the power-supply cord, within 12in. (305mm) of the attachment plug. For the purpose of this section listed cord sets incorporating ground-fault circuit-interrupter

protection for personnel shall be permitted. Egress lighting shall not be connected to the load side terminals of a ground-fault circuit-interrupter receptacle.

(b) Appliance Receptacles. Receptacles supplying items such as cooking and refrigeration equipment which are incompatible with ground-fault circuit-interrupter devices shall not be required to have ground-fault circuit-interrupter protection.

(c) Other Receptacles. Other receptacle outlets not covered in (a) or (b) shall be permitted to have ground-fault circuit-interrupter protection for personnel, or a written procedure shall be continuously enforced at the site by one or more designated persons to ensure the safety of equipment grounding conductor for all cord sets and receptacles, as described in Section 305-6(b)(2).

### **C. Grounding and Bonding**

525-20 General. All system and equipment grounding shall be in accordance with Article 250.

525-21. Equipment. The following equipment connected to the same source shall be bonded:

- (1) Metal raceways and metal sheathed cable
- (2) Metal enclosure of electric equipment
- (3) Metal frames and metal parts of rides, concessions, trailers, trucks, or other equipment that contain or support electrical equipment.

525-22. Equipment Grounding Conductors. All equipment requiring grounding shall be grounded by an equipment grounding conductor of a type and size recognized by Sectoin 250- 118 and installed in accordance with Article 250. The equipment grounding conductor shall be bonded to the system grounded conductor at the service disconnecting means, or in the case of a separately derived system such as a generator, or first disconnecting means supplied by the generator. The grounded circuit conductor shall not be connected to the equipment grounding conductor on the load side of the service disconnecting means or on the load side of a separately derived system disconnecting means.

## **D. Disconnecting Means**

525-30. Type and Location. Each ride and concession shall be provided with a fused disconnect switch or circuit breaker located within sight and within 6 ft (1.83m) of the operator's station. The disconnecting means shall be readily accessible to the operator, including when the ride is in operation. Where accessible to unqualified persons, the enclosure for the switch or circuit breaker shall be of the connect or circuit breaker when a switch located in the ride operator's console is closed shall be a permissible method of opening the circuit.

## **E. Attractions Utilizing Pools, Fountains, and Similar Installations with Contained Volumes of Water**

525-40. Wiring and Equipment. This equipment shall be installed to comply with the applicable requirements of Article 680.

## **Amusement Ride Inspectors Guide To The National Electrical Code**

This guide was prepared for the use of amusement ride inspectors who may not be totally familiar with the National Electrical Code. It is not considered to be totally inclusive or comprehensive of all items the inspector should be concerned with. **This guide is produced and distributed only as an aid to the inspector.**

### **ARTICLE 90 – INTRODUCTION**

90-2 Scope: includes carnivals, with special requirements in article 525.

### **ARTICLE 110 – REQUIREMENTS FOR ELECTRICAL INSTALLATIONS**

- 110-12.1 Wiring to be installed in a neat and workman like manner
- 110-12(a) Unused openings in boxes, etc. Shall be closed
- 110-13 Electrical equipment firmly mounted
- 110-14 Do not mix copper and aluminum connector and wires
- 110-14(a) Connections shall be good pressure device or solder joint
- 110-14(b) Splices made with suitable devices or soldered
- 110-17 Guard live parts against accidental contact @50V or more
- 110-17(a) Warning signs on boxes, cabinet, etc.

### **ARTICLE 200 – GROUNDED CONDUCTORS (NEUTRAL WIRE)**

- 200-6 Neutral wire (grounded conductor) colored white
- 200-11 Neutral wire (grounded conductor) not to be connected as to reverse polarity



## **ARTICLE 240- OVERCURRENT PROTECTION (FUSES,ETC.)**

- 240-4 Protection against overcurrent (amps) of cords and cables
- 240-9 Thermal cut-outs & relays shall not be used for fuses, etc.
- 240-20 Overcurrent device connected in series with each “hot wire”
- 240-22 No fuse on equipment ground (green) or neutral (white)
- 240-23 When size of “hot wire” changes neutral size may change
- 240-30 Overcurrent devices must be in enclosures
- 240-40 Disconnecting means on supply side of all fuses over 150V and all cartridge type fuses (allows power “off” to change fuse)

## **ARTICLE 250 – GROUNDING**

- 250-1 fpn1 Grounds are to limit and stabilize voltage, etc.
- 250-1 fpn1 Equipment ground (green) is bonded to ground rod wire to make overcurrent device operate properly
- 250-5(d) Generators to have ground rods
- 250-26(a) Neutral and ground bond together at generator
- 250-26(b) Proper wire to connect ground rod to generator
- 250-26(c) Metal building and water pipe grounds (instead of rods)
- 250-50(a) Equipment ground wire, neutral and ground electrode wire to bond at generator
- 250-51 Ground paths continuous, earth not used as wire
- 250-81exp1 Electrode ground wire may be spliced
- 250-81(a) Water pipe grounds (types allowed)
- 250-81(b) Metal frame of building grounds (types allowed)
- 250-81(c) Ground rods-must be at least 8ft long
- 250-84 Ground rods 25 oms or less –6ft apart (more than 2 unnecessary)
- 250-86 Lighting rods not to be used as ground rods
- 250-91(a) Grounding electrode conductor-materials & requirements (exct#3)
- 250-91(b) Grounding rod wire type- covered /bare, solid strand
- 250-91(c) Additional ground rods permitted with 5-wire system
- 250-92(a) Ground rod wire not required to be larger than #6
- 250-95 Size of equipment grounding conductor (table) (green wire)
- 250-99 Equipment grounding conductor continuity (green wire)
- 250-99(a) First make last break of ground connector for plugs
- 250-99(b) No switch or fuse on equipment grounding conductor (green wire)
- 250-112 Ground wire to ground rod connection
- 250-113 Ground wire & bonding jumper connectors
- 250-114 Bond all equipment ground conductors (green wire) to boxes
- 250-115 Ground wire to ground rod connector
- 250-117 Protection of ground rod wire clamps
- 250-118 Ground rod wire clamps clean

## **ARTICLE 305 – TEMPORARY WIRING**

This article deleted from guise. Carnivals, etc. are no longer covered under this article. Specific requirements for carnivals, etc. are now covered under article 525.

## **ARTICLE 373 – CABINETS AND CUT-OUT BOXES**

This article deleted from guide. Most carnivals, etc. are making their own junction boxes, etc any longer. Junction boxes covered under 525-15.

## **ARTICLE 380 –SWITCHES**

- 380-2(a) 3 way & 4 way switches shall break only “hot” wires
- 380-2(b) Switches not to be used on neutrals, unless simultaneously disconnects all conductors
- 380-3 Switches shall be mounted in enclosures
- 380-4 Switches installed in weatherproof enclosures
- 380-5 Time switches, flashers, etc installed in enclosures
- 380-7 Switches, circuits breakers labeled “off”& “on”, Up is “on”
- 380-8(a) Switches must be readily accessible
- 380-11 Circuits breakers may be used as switches
- 380-12 Switch enclosures shall be grounded

## **ARTICLE 400 –FLEXIBLE CORDS AND CABLES**

- 400-4 Flexible cords and cables shall be listed in table 400-4
- 400-5 Amp ratings for flexible cord and cable (sizing table)
- 400-6 Flex Cords and cables shall be marked
- 400-10 Flex cords connected to that tension not transmitted
- 400-14 Flex cord protected from damage by bushings
- 400-24 Flex cord attachment plugs

## **ARTICLE 402 –FIXTURE WIRES (OTHER THAN LIGHTS)**

- 402-5 Amp rating small gauge wires (#10-#18)
- 402-6 Minimum size fixture wire #18
- 402-8 Fixture wires neutral marked
- 402-10 Fixture wires uses permitted
- 402-11 Fixture wires not to be used as branch circuits
- 402-12 Fixture wire overcurrent protection

## **ARTICLE 410- LIGHTING FIXTURES**

- 410-3 Lighting fixtures-no live parts exposed
- 410-15 Light fixtures must be securely supported
- 410-17 Lighting fixtures & equipment shall be grounded

- 410-18 Exposed lighting fixtures parts-grounded or insulated
- 410-21 Light fixtures-grounded where mechanically attached
- 410-22 Light fixture wiring –neat, not exposed to damage
- 410-23 Light fixture shall be polarized
- 410-24 Light fixture conductors-suitable type & size

#### **ARTICLE 445 – GENERATORS**

- 445-2 Generator must be proper type
- 445-3 Must have nameplate listing # of phrases, kilowatts, volts & amps
- 445-5 Wire sizing from generator terminals to first fuse box
- 445-6 Live parts must be protected
- 445-8 Bushing in cabinets

### **NON DESTRUCTIVE TESTING**

Non destructive testing (NDT) plays an important role in today's Amusement industry preventive maintenance programs.

When developing a test program, care should be taken when selecting the items to be tested, and the testing discipline to be used.

Whenever possible, the ride/attraction manufacturer should be consulted for assistance in developing this program.

The testing procedure and the results of a test should be documented in detail by the personnel involved.

This document will become an important part of the maintenance history of the attraction.

The NDT schedules and procedures should be documented in detail, and along with all relevant drawings, made available to the NDT technician prior to any testing.

A form should be used to document the findings and results of any NDT performed on a particular ride or attraction.

This form should include information provided to you from the company performing the tests.

When the components to be tested have been selected, time should be taken to label/ ID each component, this is extremely important when a percentage is being calculated.

For Example:

The procedure is to test 10 wheel axles each year out of a batch of 50 identical axles, so that each axle will be tested on a 5 year rotation.

To keep an account of which axles have been tested and when, accurate marking of the components is a must.

## **NON DESTRUCTIVE TESTING PROCEDURES:**

Basic Nondestructive testing terminology:

1. **ULTRASONIC:** Based upon the same principle as sonar, this reliable and convenient method transmits sound waves through materials of known density and reflects any changes in that density on a cathode ray screen.
2. **RADIOGRAPHY:** This method employs X rays or Gamma Rays to develop a permanent film record of the internal condition of test areas.
3. **PENETRATE:** Based upon the principle of capillary attraction, this economical test method is used to locate irregularities open to the surface of ferrous and non-ferrous materials.
4. **MAGNETIC PARTICLE:** employing the principle of electrically induced magnetization, this method is an economical and rapid testing method for locating surface and near surface irregularities in ferromagnetic objects.
5. **VISUAL:** Visual inspection is exactly what the name implies. A visual inspection of components by both in-house maintenance personnel and outside NDT technicians.

Typical NDT applications within the amusement industry:

Structural Supports:	Shafts & Spindles:
Sweep arms:	Car Attachments:
Car frames:	Cables:
Structural columns:	Slide trough supports:
Chains:	Bolts:
Pins:	Hydraulic lifts:
Ride tracks:	Wheel assemblies:
Booms & Sweeps:	Weld & Weld repairs:

# HYDRAULIC HOSE

## BASIC TYPES (PAINTED HOSES)

- A) One & two wire
  - Good for medium to high pressure systems
  - Will handle hydraulic oil and fuels
  
- B) Spiral
  - Made for extreme pressures
  - Reinforced by 4 or 6 spirals of steel
  - Will handle hydraulic oil
  
- C) Thermoplastic
  - Good compatibility with Phosphate Esters
  - Clean
  - Available for nonconductive use (orange)
  
- D) Teflon
  - Excellent fluid compatibility
  - High temp. Resistance
  - Clean

## ASSEMBLY

The assembly of the coupling to the hose is very important in order for the hose to achieve the designated working pressure. The following are steps which cannot be overlooked when making an assembly:

### 1) Hose

#### A. Cut length

- Assemblies are measured from the end of one coupling to the end of the other (except in the case of a 90 or 45 degree coupling. These are measured at the middle of the bent tube.)
- The cut-off dimension for a fitting is the distance from the end of the coupling to where the hose butts up on the stem.
- If the same coupling is on each end of the hose multiply this dimension by two and subtract it from the overall length of the assembly. This dimension will be the length of hose only for the assembly.

#### B. Cutting

- Textile reinforced hose can be cut with a knife.
- Wire reinforced hose must be cut with either an abrasive blade or scalloped (relieved) blade.
- Cuts are to be made perpendicular to the hose. Without this you will not have a good bond between the stem and hose.
- Hose must be flushed or blown out before inserting the stem.

### **C. Assembly of Coupling**

- Phase Angles- Assemblies which have a bent tube on each end must be oriented correctly before crimping. This is done by putting the largest degree of bend coupling away from you facing down. (6:00) The end closest to you is to be measured clockwise.
- Fitting must be inserted completely onto hose. This can be checked by placing the coupling beside the hose and marking a line on the hose on the hose on the hose where the end of the socket would be.
- Oil may be placed inside the hose, but by no means on the outside.

### **D. Cleaning**

- Hose should be cleaned and capped before shipping.

## **APPLICATION**

In picking the correct hose for the application the following questions should be asked:

- 1) Size-hose.
- 2) Temperature of fluid.
- 3) Application – used for & attached to.
- 4) Medium- substance (fluid)
- 5) Pressure – bar x 15 x 5
- 6) Ends – fittings
- 7) Dimensions – length (Orientation)

## **INSTALLATION**

Parameters:

1. Appearance- look, neat, use less hose and fittings

- a. Keep hose assemblies routed in straight lines following the contours of the equipment.
- b. Route hose lines together and parallel.
- c. Use brackets or clamps to keep hoses from rubbing each other in place.
- d. Use proper length hose assemblies, excessive slack major cause of poor appearance.
- e. Use adapters(45 or 90) to provide for more direct routing and reduce the amount of hose.
- f. Use flared fittings( elbows and adapters) to improve appearance, shorten assembly time and reduce the number of pipe joints (leakers).

## **Adapters – 4 functions:**

1. Join hose or to tube to component.
2. Connect 2 or more tubes together or a tube to a hose (TEE shaped) 90 degree used for right angle connection
3. Bulkhead – Thru solid area rather than going around.
4. Reducing adapter – used to eliminate need for bushing.  $\frac{3}{4}$  NPTF to  $\frac{1}{2}$  JIC to hose (eliminate s bushing).

## **Access to Service**

90 Deg. Adapter plus straight fitting can be difficult to service – this can be corrected using a straight adapter and 90 deg. Elbow fitting.

## **Abrasion**

- Caused by constant rubbing on a sharp edge, contact with moving parts, crisscrossing of hose, improper use of clamps.
- Clamps can be used to clamp hose and prevent contact with surfaces which abrade hose. Elbow adapters or long tangent fitting can sometimes be used to reroute the hose enough to avoid abrasion.

## **Minimum Bend Radius**

- Always pay attention to the minimum bend radius.
- Hose should always exit the fittings in a straight line for a min. distance of one inch before a radius is started.

## **Flexing Applications**

1. Watch for abrasion
2. Provide enough hose to allow for movement.
3. Remember the fitting is NOT flexible.
4. A clamp can be used to divide a single hose into 2 hose assemblies.

When installation requires the hose intersect with 2 different planes.

- a. Use a longer length of hose.
- b. Clamp at point where it changes planes.

## **Ambient Heat**

Manifolds – route away from or use a heat shield.

## **Controlling leakage**

- Oil leakage can cause unsightly and hazardous mess. Keep joints to minimum and reduce number of pipe threads to a bare minimum.
- Straight thread o'ring and split flange style fittings are superior to other types of fittings.

## **BEST FOR LAST**

### **Cleanliness**

- Very important – a dirty hose line can be compared to a clogged artery. It can caused heart failure or in the case of hydraulics, cause pump failure.
- With a new piece of hydraulic equipment, a company assumes it can fill the reservoir, start the engine and go to work. Doing this can shorten pump life several weeks in just a few minutes.
- Prefill the lines to the pump to eliminate serious wear at the first start-up.



## Common Causes of Hose Failure

## Pressure Rating

1. Improper pressure range
2. Excessive temperature—internal/external
3. Fluid compatibility
4. Exceeding minimum bend radius
5. Improper hose size, internal diameter
6. Hose/fittings mismatch
7. Improper routing and installation
8. Improper alignment
9. Excessive abrasion
10. Improper use

### 1. Pressure Rating

Hoses should never be subjected to pressure greater than their rated working pressure. When the working pressure is exceeded, the safety factor is reduced. This results in a greatly shortened service life and premature failure, such as hose rupture or even blow-offs. Premature failure increases operating costs since the frequency of replacement and downtime are increased.

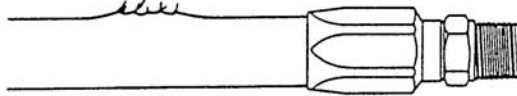

Hydraulic systems often experience momentary increases in pressure (surges and shocks) that are too short in duration to actuate the relief valve. Where these pressure pulses are high enough and occur often enough, they exert considerable stress on the hose and reduce its life.



Pressure peak: can cause failure in the hose—or at a fitting.



## Common Causes of Hose Failure

## Pressure and Temperature Rating

When excessive pressure surges can be anticipated, a hose with a higher pressure rating should be selected.

### 2. Temperature Rating.

Temperature extremes, both internal and external, are major contributors to early hose failure. Hose which is continuously exposed to heating and cooling cycles will experience accelerated deterioration. When these cycles occur in conjunction with repeated pressure surges, hose service life is shortened drastically.

Hoses may become embrittled through exposure to exterior temperatures of several hundred degrees. This condition may be created by poor routing where the hose may be located near a manifold or other hot spot. In such a case, hose must be rerouted or shielded from the heat source.

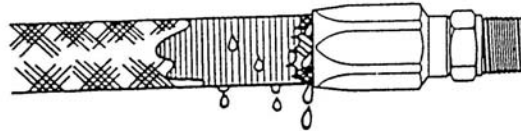

Misapplication—too much heat embrittles the rubber.

# Common Causes of Hose Failure

# Fluid Compatibility and Exceeding Bend Radius

Temperature and Pressure . . .

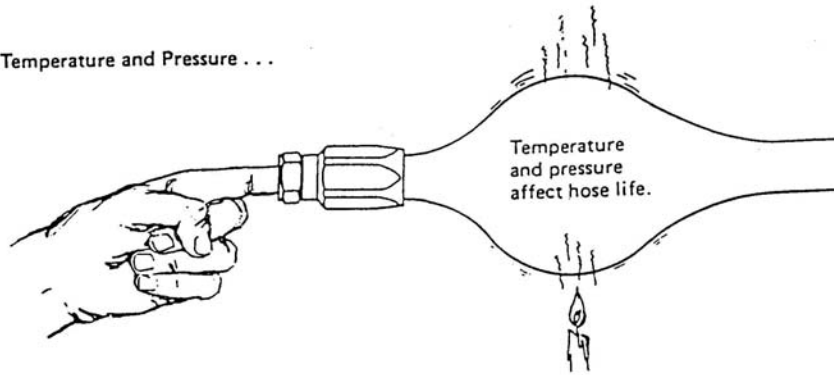

### 3. Fluid Compatibility

The third major consideration in the proper selection of hoses is fluid incompatibility. This subject is covered in detail in the section on hose characteristics.

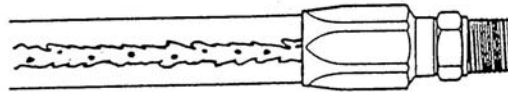

Incompatible fluids affect the tube or liner—it may embrittle, soften, dissolve, shrink or swell, causing leakage at or away from the fittings, blow-offs, or solid particles may clog valves and filters.

### 4. Exceeding the Bend Radius

A bend radius that is too tight will result in reduced hose life. When a rubber hose exceeds its maximum bend radius the outside may appear smooth even if the inner tube is kinked. So, it's important to measure the bend radius, as shown below to check that it is within stated limits. The detection of excessive bends is not a problem with thermoplastic hose since a kink is readily apparent and the hose can be immediately rerouted or different adapters used to correct the condition.

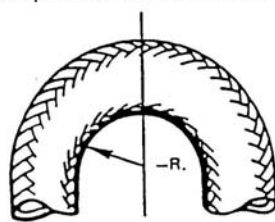

Bend is too small.

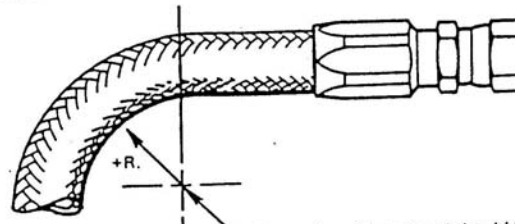

Center line of hose bend should be well away from fitting.

## Common Causes of Hose Failure

## Size and Hose Fitting Mismatch

### 5. Size

If the hose selected has an I.D. that is too small to handle the full flow demanded by the system, flow is restricted by friction. Friction results in heat, and heat leads to reduced hose life.

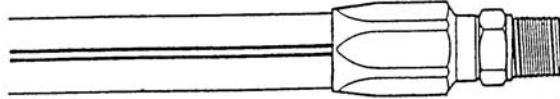

Line too small—affects flow, causes friction. Hose and fluid get very hot.

### 6. Hose/Fitting Mismatch

When a hose blows away from a fitting, the cause may be traced to either (1) a mismatch, where the wrong fitting has been selected for a particular hose, or (2) the fitting was improperly installed.

A typical hose/fitting mismatch is one in which the wall thickness of the hose is too large for the fitting so that the fittings will not seat completely onto the hose without damaging one or both.

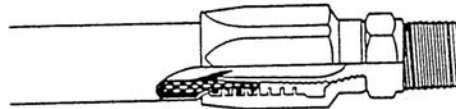

Hose too thick. Can't get the fitting on properly. Hose liner cut.

Similarly, when a low pressure hose is assembled into a high pressure fitting, blow-off occurs because the hose wall is too thin to be gripped adequately. If the hose does not blow off, it may leak.

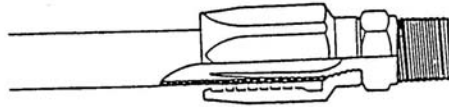

Hose too thin

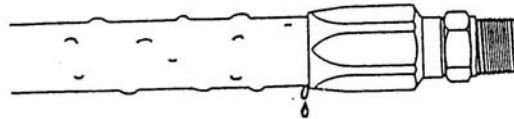

Result: Failure—fitting blow-off or bubbling of cover and leaking around socket.

## Common Causes of Hose Failure

## Routing, Installation Alignment and Abrasion

### 7. Routing and Installation

Improper routing and installation, as well as poor workmanship cause more hose failure as any other cause. The proper installation costs no more than the wrong installation at the outset. The trouble and added costs resulting from a poorly installed system come right after startup. So why not learn to do it right?

Some tips for a proper installation follow:

In straight hose installations, leave some slack in the line. Pressure changes can cause a hose to lengthen up to 2% or shorten up to 4%. A 100-inch assembly, for example, can contract to 96 inches. If the line has no slack, the hose will tend to pull away from the fitting and will be damaged.

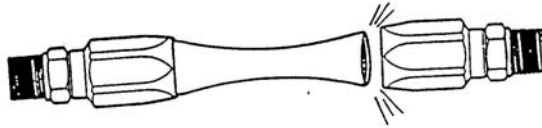

Hose too short—hose will contract under pressure, shortening as much as 4 percent. A 100-inch assembly will contract to 96 inches.

### 8. Improper Alignment

Keep the lay line on the hose straight. Avoid twists in the hose. A 7% twist in the hose can reduce its life by up to 90%. Also, a twisted hose under pressure tends to untwist. This can cause it to loosen the fitting from its connection.

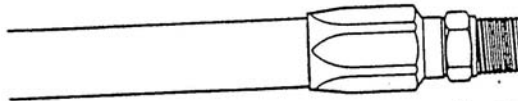

Twisting—seven percent twist reduces life 90 percent. Keep lay line straight.

### 9. Abrasion

Route hoses to avoid rubbing or abrasion between hoses or between hoses and components. While relative motion caused by moving parts is obvious, don't overlook motion created by vibration. Clamping also helps keep hoses away from adjacent components.

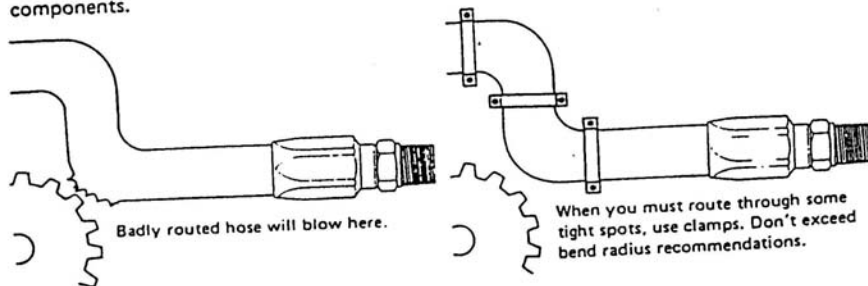

Badly routed hose will blow here.

When you must route through some tight spots, use clamps. Don't exceed bend radius recommendations.

# Common Causes of Hose Failure

# Improper Use

10. Improper Use  
Treat hydraulic hose like hydraulic hose!

It's not to hang on

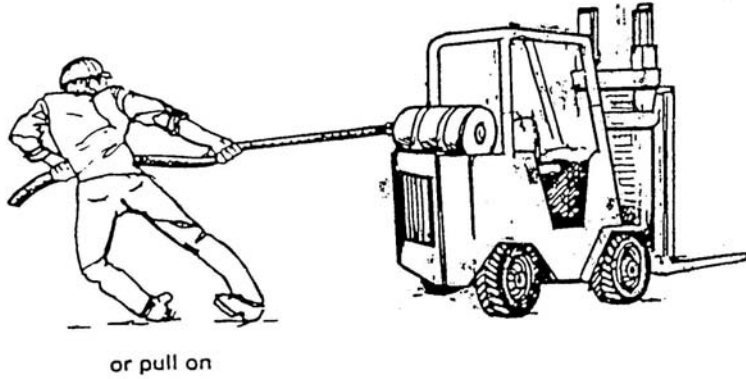
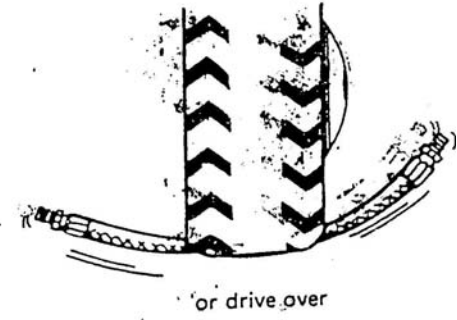
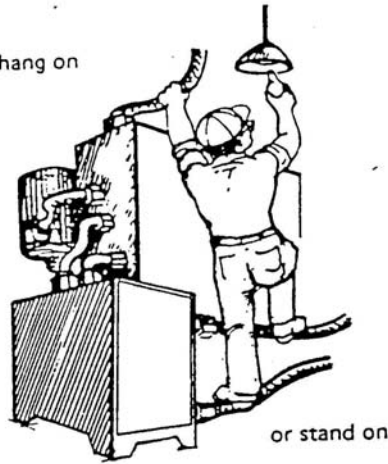

All of these practices will shorten its life.

## IDENTIFICATION OF FASTENER GRADES

Virtually every mechanical assembly used by industry, transportation and construction is literally held together with fasteners.

Few of us realize how important the quality of these fasteners are in assuring that the equipment we depend on daily is safe and reliable.

Before a mechanic can select the correct grade of fastener for the application and determine the proper installation torque, he must know the strength of each grade and be able to tell one from the other. This becomes vitally important when a mechanic removes an OEM specified bolt from a connection to perform regular maintenance. The mechanic must identify the grade of fastener removed and replace that bolt with the SAME grade.

Failure to do so could result in an accident because of a lesser grade bolt used in the connection. This may cause expensive property damage and/or severe personal injury. Extensive liability suits could result.

Four nationally recognized technical groups of engineers define fastener standards and specifications. These organizations are the Society of Automotive Engineers (SAE), the American Society for Testing and Materials (ASTM), the International Standards Organization (ISO), and the Industrial Fastener Institute (IFI). They have established a method of identifying various grades of fasteners. They also established the minimum strength requirements, chemical analysis of steel to be used and, where called for, the degree of heat treatment that is permissible for each grade. The following chart shows the head markings in use, and the material and mechanical requirements for each SAE grade.

Besides the standard grad markings on the heads of the fasteners, as indicated in the Head Marking Chart, most fasteners manufactured in North America have a manufacturer's identification logo placed somewhere on the product.

A listing of these logos is found in the IFI-122 publication issued by the Industrial Fasteners Institute, Cleveland, Ohio. The purpose is for identity and traceability. These fasteners HAVE to meet the indicated SAE specifications. If, for instance, there are just three radial lines on the head, indicating it to be Grade 5, with other markings, then the bolt is imported. This is very important because U.S. laws do not apply in foreign countries. We are not to say that imported fasteners without a manufacturer I.D. do not meet SAE specifications...they just don't HAVE to meet them; and there is no incoming inspection made of imported fasteners by the brokerage firms that import and distribute them.

The Bowman Distribution Engineering Department has tested imported bolts marked with Grad 8 radial lines that did not meet Grade 5 specifications; yet others out of the same box, identical in appearance, would meet the required specifications. The point is, with imported bolts, you must know **WHAT** you are buying.

Imported fasteners are purchased by brokers who buy from many different sources. In the case of a liability claim, if there isn't a manufacturer's I.D., there is absolutely **NO WAY** to trace the manufacturer of the bolt.

The chart in this book lists the different SAE and Metric grades of fasteners.

With the trend of downsizing in the automotive industry and the increasing use of metrics, original equipment manufacturers could not rely upon the strength of the Property Class 8.8. Instead, they have automatically upgraded themselves with an increase in strength by specifying the 9.8 Property Class.











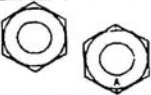





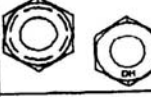

Although some Grade 6 fasteners (formally discontinued by SAE in 1964), or those marked with only four radial lines, may have tensile strengths which are close to or compare to those of the Grade 8, **NEVER** substitute a Grade 6 for the Grade 8. They will not meet the SAE Grade 8 steel chemistry requirements. Where an SAE Grade 8 cap screw is specified, or designated as OEM, **ALWAYS** make replacements with the **SAME** grade to prevent liability claims. Consult your service manuals or factory representative for verification.

## **Glossary of Terms**



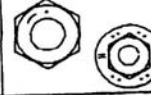





ASTM	American Society for Testing Materials (Chemical & Physical Specifications)
ANSI	American National Standards Institute (Dimensional Specifications)
SAE	Society of Automotive Engineers Specification of Grade 5 and Grade 8 Hardware
ASME	American Society of Mechanical Engineers
ISO	International Organization for Standards
FQA	Fastener Quality Act (Public Law 101-592) To be enacted May 27, 1998

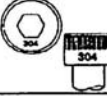

## BASIC FASTENERS

Product Grade Identification	Industry Standards	Material	Nominal Product Diameters	Tensile Strength PSI	Product Hardness Rockwell	Marking Requirement For Matching Nut
	SAE J429 Grade 1	1010 - 1020 Low Carbon Steel	1/4 thru 1 1/2 and bolts longer than 6"	60,000	B70 - B100	
	SAE J429 Grade 2	1018 - 1020 Low Carbon Steel	1/4 thru 3/4 over 3/4 to 1 1/2	74,000 60,000	B80 - B100 B70 - B100	
	ISO R898 Property Class 5.8 SAE J1199	Low or Medium Carbon Steel, cold worked	M5 thru M24	75,400 (520 MPa)	B82 - B95	
	ASTM A449 Type 1 SAE J429 Grade 5	1035-1038 Medium Carbon Steel, heat treated	1/4 thru 1	120,000	C25 - C34	
			Over 1 thru 1 1/2	105,000	C19 - C30	
	ISO R898 Property Class 8.8 SAE J1199	1035-1038 Medium Carbon Steel, heat treated	M4 thru M16	116,000 (800 MPa)	C20 - C30	
			M17 thru M36	120,350 (830 MPa)	C23 - C34	
	ASTM A193 B - 7	4140-4145H Chromium-Molybdenum Alloy Steel	Threaded Rod and Studs 2 1/2 and Under	125,000	—	
	SAE J429 Grade 8	Carbon steel	1/4 thru 3/4	150,000	C33 - C39	
		15-11 Carbon Steel	7/16 and Smaller			
		Medium Carbon alloy	other sizes			
	ASTM A354 Grade BD	Special Alloy Steel, oil Quenched & Tempered	1/4 thru 1 1/2	150,000	C33 - C39	
	SAE J429 Grade 8.2 SAE J1199	Low Carbon Boron Martensite Steel, Quenched & Tempered, Limited Use	Hex and Flange 1/4 thru 1	150,000	C33 - C39	
	ISO R898 Property Class 10.9, ASTM F568	Medium Carbon Alloy Steel, oil Quenched & Tempered	M6 thru M36	150,800 (1040 MPa)	C33 - C39	
	Karalloy Special	Proprietary Fine Grained Alloy Steel, oil Quenched & Tempered	1/4 thru 1	180,000 - 200,000	C38 - C42	

## BASIC FASTENERS

Product Grade Identification	Industry Standards	Material	Nominal Product Diameters	Tensile Strength PSI	Product Hardness Rockwell	Remarks
	ASTM A307 Grade A	1010 - 1020 Low Carbon Steel	1/4 thru 4	60,000 (414 MPa)	B69 - 100	Structural bolt dimensions, marked 307A
	ASTM A307 Grade B	1018 - 1020 Low Carbon Steel	1/4 thru 4	60,000 (414 - 690 MPa)	B69 - 95	Structural bolt dimensions, marked 307B
	ASTM F837 Group 1	Stainless Steel Type 304	.060 - .625	95,000	B80	May be marked; 304 or 304CW : Condition is cold worked (CW) marking on top or side
			.750 - 1.50	70,000	B74	
	ASTM F837M Property Class A1-50	Stainless Steel Type 304	M6 - M36	500 MPa	B70 - B95	Metric stainless socket head, may be marked A1-50, top or side markings
	ASTM F593C	Stainless Steel Type 304	1/4 thru 5/8	100,000	B95 min	Cold worked product, may be marked C or D for size; alternates 304 or UNS 30400
	ASTM F593D	Stainless Steel Type 304	3/4 thru 1 1/2	85,000	B80 min	
	ASTM F593G	Stainless Steel Type 316	1/4 thru 5/8	100,000	B95	Cold worked product, may be marked G or H for size; alternates 316 or UNS 31600
	ASTM F593H	Stainless Steel Type 316	3/4 thru 1 1/2	85,000	B80	
	ASTM F468	Silicon Bronze	1/4 thru 3/4	70 - 100,000	B75 - B95	May be marked F468K, C65100, 651; Metric standard is found in F467
			7/8 thru 1 1/2	55 - 90,000	B70 - B95	
	ASTM A325	Medium Carbon, Carbon Boron, or Medium Carbon Alloy Steel	1/2 thru 1	120,000	C25 - C34	Structural bolt dimensions; larger head, short thread length
			1 1/8 thru 1 1/2	105,000	C19 - C30	
	ASTM A490	Medium Carbon, Alloy Steel	1/2 thru 1 1/2	150,000	C33 - C36	Structural bolt dimensions; larger head, shorter thread length; NEVER coated.
	ASTM A574	4140-4145H Alloy Steel	1/4 thru 1/2	180,000	C39 - C45	Standard U.S. thread socket products are all same grade—no marking. Knurl pattern is Mfg. mark
			5/8 and larger	170,000	C37 - C45	
	ASTM A574M	Alloy Steel	M6 - M48	1200 MPa (174,000)	C38 - C44	Marking on top or side, knurl pattern is Mfg. I.D., ISO/DIN specifications include 8.8 and 10.9 classes

## Inspection

### Joint Inspection

Some joints will appear to wear rapidly on new rides. This is usually a result of the holes not aligning in the mating parts. When this condition occurs it results in “point contact”. A joint with this condition will generally wear rapidly until the load is distributed evenly over the fastener and the parts.

If in doubt about the condition of a bolt, pin or hole on a new ride consult the manufacturer, and replace as required.

1. Inspect stationary joints for “egg-shaped” wear and loose pins

1. Stationary joint wear
2. Stationary joint-misaligned holes resulting in point contact

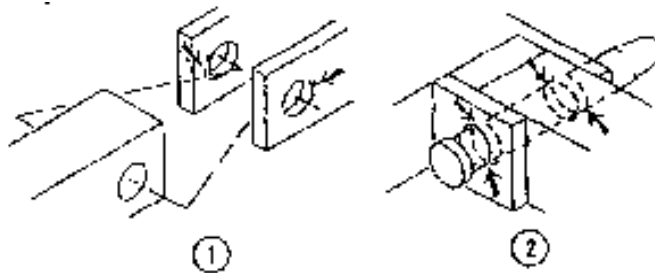

2. Inspect moving joints for wear and lubrication.
3. Inspect welded structural joints for cracking or fatiguing.
4. Inspect bolted structural joints for cracking, fatiguing and proper bolt tightness.
5. Inspect pins and keepers on all pin joints for wear and proper installation.
6. Inspect all pins for proper manufacturer identification marks.

### Cable Inspection

Replace cables if any of the following conditions exist. If more than one cable is used, cables must be replaced as a set.

1. Severe corrosion
  - a. Rust appearing to stem from interior of cable.
  - b. Cable appears clean but previous corrosion is evident from pitted condition in wires.

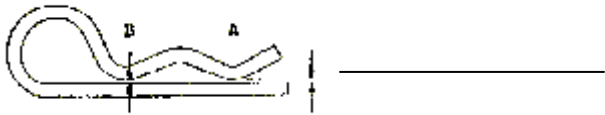

**Acceptable hair pins**  
 Dimension "A" equals  
 dimension "B" in a relaxed  
 position

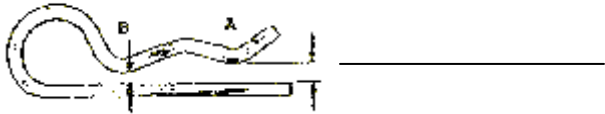

**Unacceptable hair pins**  
 Dimension "A" is greater than  
 dimension "B" in a relaxed  
 position

**NEVER ATTEMPT TO BEND A HAIR PIN BACK INTO SHAPE  
 REPLACE IT WITH A NEW PART.**

The correct installation of a hairpin is shown. Incorrectly installed hairpins are more likely to fall, and will distort after only a few users.



Recognize and recommend the safety procedures specified in ASTM Standards F770 Operation Procedures for Amusement Rides and Devices and F853 Maintenance Procedures for Amusement Rides and Devices.

## **FIRE SAFETY & FIRE EXTINGUISHERS**

Fires have played a part in the amusement industry for many years. In the early 1900's fire destroyed many amusement piers and parks. In the mid-eighties, a devastating fire in New Jersey claimed the lives of 7 teenage park visitors while they were walking through a Haunted House type attraction made up of a series of trailers. Amusement ride regulations were implemented by a number of states, including Pennsylvania, following the fire in New Jersey.

Fire Safety and Fire Extinguishers play a part in the inspections, operations and maintenance of every fixed site and mobile amusement operation. Areas of concern in the amusement industry include such things as Walk through Attractions, Gas Powered Rides, Generators, Stock Trailers and Warehouses, electrical Equipment, Dark Rides, Flammable and Combustible Liquid Storage, as well many other attractions, amusement rides and devices to numerous to mention.

The National Fire Protection Association (NFPA) has classified four general types of fires, based on the combustible materials involved and the type of extinguisher needed to put them out. The four fire classifications are A,B,C and D. Each classification has a special symbol and color identification

### **General Classes of Fires**

- Class A: This type of fire is the most common. The combustible materials are things such as wood, cloth, paper, rubber and plastics. The common extinguisher agent is water, but dry chemicals are also effective.
- Class B: Flammable liquids, gases and greases create class B fires. Extinguishers to use are foam, carbon dioxide and dry chemical.
- Class C: These fires are electrical fires and non-conducting agent must be used. Carbon dioxide and dry chemical extinguishers are to be used.
- Class D: Combustible metals fires such as magnesium, titanium and sodium.
- Class E: These fires require specialized techniques to extinguish them.

## Types of Fire Extinguishers

Here is a list of fire extinguishers most commonly found in an amusement operation:

- Water
- Carbon Dioxide
- Dry Chemical
- Multipurpose Dry Chemical

Multipurpose fire extinguishers (ABC) will handle all A,B, and C fires. All fire extinguishers are labeled with either ABC, or A, or B or C, so be sure to read the labels.

## How to Use a Fire Extinguisher

Even though extinguishers come in a number of shapes and sizes, they all operate in a similar manner. Here's an easy acronym for fire extinguisher use:

***P A S S - Pull , Aim, Squeeze, Sweep***

- |                |   |
|----------------|---|
| <b>PULL</b>    | the pin at the top of the extinguisher that keeps the handle from being accidentally pressed.   |
| <b>AIM</b>     | the nozzle toward the base of the fire  |
| <b>SQUEEZE</b> | stand approximately 8 feet away from the fire and squeeze the handle to discharge the extinguisher. If you release the handle, the discharge will stop. |
| <b>SWEEP</b>   | the nozzle back and forth at the base of the fire. After the fire appears to be out, watch it carefully since it may re-ignite!                         |

## Suggested Areas to Check during Fire Safety Inspections

- Trash and litter, no unnecessary accumulation
- Housekeeping, rides and work areas neat and clean
- Fire extinguishers, well marked, correct types, charged and ready to go
- Hazardous Materials, stored in designated areas
- Exits, well marked and unobstructed
- Wiring, good connections, good grounds, insulation intact
- Smoking, only in designated areas, signs posted
- Flammable materials, being handle with care, sign posted where applicable

\*\*Please note, this is not an all-inclusive list. Inspectors are encouraged to develop their own list of inspection points.

## **Waterpark Attractions**

Waterparks present a safety inspector with a major challenge to the effectiveness of their efforts because no two facilities or attractions are the same. A Scrambler is a Scrambler wherever it is operating but this is not true of Waterpark attractions. Circumstances assessed in one scenario may not be the same in a similar appearing arrangement in another facility. The inspector must be cautious to not generalize when attempting to set parameters for safety in these aquatic family recreation centers.

Waterpark inspections are further clouded because the attractions deal with few mechanical considerations such as blocking, ride assembly, NDT and other aspects which are normally part of a typical amusement ride. Couple this with the fact that, in most Waterpark attraction, the guest has a strong sense of and some real control over his or her experience and the inspection process gets even cloudier.

The key factor in Waterpark operations is an attentive staffing that is well trained and continuously doing their job. Industry practice is pretty consistent and clear in these areas and offers specific checkpoints for the inspector. The inspection of a Waterpark for hazards and exposure to injury demands the inspector pay close attention to staff procedures, behavior, training and conduct as well as the attractions themselves. An inspector should check to make sure that a documented training and operations program is on file and being implemented. A check of rescue equipment for condition and availability should be made.

## **Serpentine Slides**

Slides of all types must be supervised at the point of dispatch. This does not mean that each flume needs to have an attendant but the arrangement of the work station and guest traffic control must assure that the attendant has full control of the guests to the point where they cannot enter the flume without direction or authorization.

There should be no significant water dripping from slide joints. If it looks like the situation has been ongoing, take a closer look at the structural conditions to see if there is obvious advanced stages of rust or scaling.

There should be no buckles or unaligned joints in the slide path and there should be no raw edges of fiberglass within reach of the guests. These often cannot be seen unless the inspector walks the slide which usually means being at the park prior to opening or after closing.

Head first sliding is generally not acceptable unless the slide is specifically designed for it. Multiple riders (2 or more) are also generally prohibited unless the slide is designed to accept this arrangement. At no time should riders be allowed to kneel or stand while riding the flume.

## **Speed Slides**

Speed slides, for the most part, have straight slide paths, features flat bottoms and near vertical shallow flat sidewalls. These attractions will characteristically have short distances, vertical drops and high speeds. Most speed slides end in run out chutes or a combination of run out chute and catch pool. Safety on these attractions depends on the rider following specific instructions of the dispatch attendant with respect to riding posture and on clear communication between the top and bottom attendants regarding dispatch of riders.

## **Catch Pools**

Catch pools can vary in size depending upon the attraction. Generally the distance from the slide mouth to the opposite wall should be 20-25 feet. Water depth can vary as well depending upon the application but 36 inches is generally a standard guide at the slide exit. The 36 inch minimum rule applies more clearly to slides which discharge the rider more than 2 inches above the catch pool surface.

Staff should not permit guests to linger or play in the catch pool. Where the slide discharges in to a conventional swimming pool, there must be a clearly marked catch area and permits no general play or swimming in the area. In these installations, the catch area should be monitored by a dedicated guard.

## **Slow Rivers**

Slow rivers are manmade streams which are level and have a slow stream, boosted by pumps. The 2-3 mph stream will generally vary in width from 8-14 feet and range in depth from 27-48 inches. Guests float along the river on floatation devices which are generally innertubes. Guests must sit or recline at all times while floating on the river.

Safety depends upon an attentive guarding staff working within the 10/20 rule (a guard must be able to scan his or her designated area every 10 seconds and must be able to respond to a person in distress within 20 seconds).

Access to and egress from the rivers must be fenced sufficiently to clearly define entry and exit points and the fence must be located so guards have full access to the river perimeter.



The river must meet all standard operating procedures including depth markers and identification of discontinuities in the side walls and floors where booster nozzle may be located.

## **Wave Pools**

Wave pools can vary widely in type and style. The most dominant is the wave action pool which produces one or more wave patterns, usually having a crown to valley displacement of less than 3-4 feet. Typically 75% of the pool surface is less than 4 feet deep. Guards must closely adhere to the 10/20 rule (a guard must be able to scan his or hers designated area every 10 seconds and respond to a person in distress within 20 seconds) and must aggressively control horseplay among the guests. Generally the waves are on for 10-12 minutes and off for a similar amount of time simply because the action is very tiring and guests tend not to leave the water to rest unless the waves stop.

Tsunami pools generate a single large wave (up to 8 feet high) on a slower frequency than the action pools. A single wave passes through the pool every 2-10 minutes. This type pool unlike the action pool has characteristic secondary wave patterns, draughts, cross currents and back flows which are seemingly random in pattern and continue for several seconds to a couple of minutes after the main wave passes.

Access to both types of pools should be restricted to the “zero depth end” only and the balance of the pool perimeter should be clearly marked or fenced to prevent guest access. Guest are not permitted to hang on sidewall ladders which should be marked for emergency use only.

## **Activity Pools**

Activity pools for small children feature a random array of play attractions in water which ranges from very shallow to several feet in depth. These play attractions must be supervised and controlled by staff and parents. Signs and attendant direction should require parents to supervise the activity of their children.

Adult pools may be deeper in depth with some having water depths to 13 feet if the attractions drop the guests any significant distance above the water. Diving is never permitted but jumping feet first or being ejected feet first is permissible with the deeper water depths. As with the kids pool, close supervision is required. Cable drop rides, canon ball slides, rock jumps, swing out slides and similar devices require supervised dispatch and close monitoring of the catch areas.

In addition to the 10/20 rule it is important to verify the total number of lifeguards on duty. Lifeguard chairs should be placed to minimize glare on the “after and in” position to give complete visual coverage of the pool. The number of lifeguard chairs required is:

Lifeguard Chairs	Pool Surface Area (sq.ft.)
0	1000 or less
1	1001-2000
2	2001-4000
3	4001-6000
4	6001-8000
5	8001-10000
Note: Over 10000sq. ft. the ratio is 1 chair for every 2000 sq. ft. of pool surface area.	

The four main areas of concern when inspecting a water park:

- Inspection of the equipment and attractions
- Check of the operational and training procedures
- Conduct of the staff and guests during operation
- Signage

### **Go – Karts**

A safe go-kart facility requires not only inspection of the go-karts but an inspection of the track, pit area and barrier systems as well. Most manufacturers provide owner / operator manuals detailing inspection, operation and maintenance procedures. You should always follow the manufacturers specifications and ASTM standards as they apply to go-karts according to state regulations.

### **Track and Pit Area**

Walk the entire length of the track and pit area. Pick up any debris lying on the track, including behind the barrier system. Debris left behind the barrier could be blown onto the track and cause a serious problem. The track and pit area should be swept or vacuumed prior to opening each day and checked throughout the day debris. Drainage elements should also be checked and cleared of any debris.

Check any metal rail elements in the barrier system, for broken welds, loose or missing bolts, kinks and sharp edges. All rubber elements (tires, D rubbers, etc.) must be inspected for failure, fatigue, proper fastening and cracking.

Gates leading to and from the pit area must be in good working condition and have functioning gate locks. Any defects found in the barrier system or pit area must be repaired prior to opening.

The track and pit surface must be checked for holes, cracks, open joints or broken pavement. The surface should be relatively smooth and clean. Repairs should be made to any existing or potential problems before opening the track.

Perimeter fencing around the track must be configured to restrict access to the riders. The only access for the riders should be clearly marked to define the entrance and exit points. The fence and queue lines should be in good repair and free of sharp edges or catch points.

Signage explaining rules and restrictions must be placed at the entrance to the track. All signs must be legible, visible and enforced. When an audio system is used in conjunction with signage, it must be checked for proper operation, volume and clarity.

Track and pit area lighting should provide adequate visibility for evening operations. All lights and wiring should be in good repair and comply with the National Electric Code. Safety lighting should also be inspected for its function and use.

Fire Extinguishers must be in good working condition, the correct size and type, easily accessible and located in the proper places.

## **KARTS**

The structural inspection should start with the frame. The frame should be straight with no bent, broken, or dented tubing. Check all welds for cracks. The body should be secured to the frame. Make sure all mounting brackets are in place and securely attached to the body and frame. The body should be complete with no missing panels or pieces. There should be no sharp or rough edges.

Tires should be in good condition with no signs of dry rot or cracking. Tires should also be inflated to the proper pressure. Wheels and hubs need to be checked for cracks and signs of being bent or damaged. Inspect the wheel studs and lug nuts to make sure that they are tight and none are missing. All karts must have wheel protection and bumpers.

The steering mechanism must be checked for excessive free play, bent tie rods, loose or worn bolts and pins and padding on the steering wheel. There should be nothing to obstruct the full turning range of the wheels.

Check the condition of the drive and braking systems. All sprockets, pulleys, chains and belts must be in good condition and free from defects. All brakes must work and should not cause the kart to pull to either side when applied. Guarding must be in place to avoid contact with any moving parts. The guarding should also prevent clothing or long hair from becoming entangled in the drive or braking mechanisms.

The engine and lines must be checked for gas and oil leaks. Any hot parts of the engine must be guarded to insure against contact while riding or getting into or out of the kart. The throttle linkage and governor must be lubricated and adjusted to avoid sticking or overspeed. All lock nuts, retainers and keepers must be in place on the throttle linkage.

Padding is required on the steering wheel and headrest. Any padding should be in good condition with no rips or tears. Seat belts must meet manufacturers specifications.

## **REASONS TO SHUT DOWN TRACK OPERATIONS**

1. Broken or failed sections of the barrier system.
2. Failure of the lighting system during and night operations.
3. Serious incidents on the track.
4. Any pavement failures or holes developed on the driving surface.
5. Fuel spills
6. Rain
7. Standing water on the track
8. Heavy deposits of dirt, leaves or other debris that may effect control of karts.

Each go-kart facility should have specific written polices and procedures for dealing with each problem listed above. They should also have polices and procedures for training, maintenance, operations and inspection.

# **Inflatable Attractions**

## **Set-up Procedures**

The site selected for set-up should be clear of debris and overhead obstructions. Toll out the inflatable and make sure it is fully stretched out. Anchor the inflatable according to the manufacturer's specifications. Attach the blower(s). Before plugging in the blower(s) make sure the power cord and receptacle are the proper voltage and amperage.

## **Daily Pre-Opening Inspection**

Check the ride and surrounding area for debris. Make sure the blower(s) and all anchoring devices are attached properly. Inspect the blower(s) for proper guards and shields. Check all electrical cords for defects and proper connections. Inflate the ride and check inside and outside for rips, tears and debris. Check for signs of aging and cracking. A warning sign stating the rules must be present in good condition, legible and visible to riders.

## **Operating Procedures**

Each operator should read and understand the operator's manual. The ride should not be operated in high winds. Most manufacturers set a maximum allowable wind limit (usually 25 mph or less). Riders must remove their shoes and loose or sharp objects including facial jewelry. The rated capacity of the ride should never be exceeded. The operator should always watch the riders and not allow any horse play. All posted rules should be strictly enforced.

## **Maintenance and Repairs**

All maintenance or repairs should be done in accordance with the manufacturers specifications. Materials used for repairing should be obtained from or recommended by the manufacturer.

## **Emergency Procedures**

Emergencies can arise for various reasons. The owner/operator of an inflatable device should have an emergency procedure policy. During an emergency the operator should remain calm and help the patrons exit the ride quickly, but in a safe orderly fashion. After everyone has exited the ride, the company's policy for shutting down a ride should be implemented. Before the ride is to be put back in service it should be inspected by a qualified inspector.

## **Controlled Substances**

1. The substance abuse indicator must be observed and documented by the trained supervisor.

The supervisor has to know the organization program & policies along with the state and federal regulation.

The policy must be explained to all employees.

Some indicators may be a result of health problems or personal problems instead of substance abuse.

### **ALCOHOL AND FACTS**

A contributing component to problems in the workplace is alcohol which will increase absenteeism and diminish productivity.

Ethanol is alcohol's active ingredient.

One can of beer, one glass (4 oz) of wine, or a shot of liquor is one drink in ethanol equivalents.

BAC – Blood Alcohol Concentration is the concentration of alcohol in the blood.

Consuming one drink raises the BAC to 0.02%

BAC typically reduces by 0.02% per hour.

Factors of alcohol absorption in the body vary with each individual and also with factors like; gender, weight, age, rest, afflictions and medication.

Alcohol is the most abuse drug while prescription drugs is second.

Cough syrup and mouth wash among other product can produce a positive test. A positive alcohol test is never a false positive test.

“American workforce” reports heavy drinking is as high as 5%.

Consuming 5 or more drinks per occasion on 5 or more day with 30 days is considered heavy drinking.

The light or occasional drinker will have a more difficult time hiding the signs of drinking as compared to an experienced drinker whose metabolisms has adjusted to the alcohol and will mask it with gum, mints and foods.

It is difficult to see signs of misuse of a long-term user of alcohol since they have developed a high tolerance.

A supervisor should be aware of 4 indicators that apply to substance abuse: physical, behavior, speech, and performance.

## **INDICATORS OF ALCOHOL**

### **PERFORMANCE**

- Change in safety procedures
- Inefficient, slowed down
- Asking unusual questions
- Confusion

### **BEHAVIOR**

- Compare current to past behavior
- Boisterous, argumentative
- Avoidance
- Withdraw
- Interaction with others

### **PHYSICAL**

- Breath or body odor
- Loss of coordination
- Change in appearance
- Sluggishness

### **SPEECH**

- Slurred, slowed or exaggerated
- Nonsensical speech pattern

## **MARIJUANA**

The active ingredient is marijuana and hashish is tetrahydrocannabinol (THC). Whether smoked or ingested, it creates an initial euphoria, followed by a sense of relaxation, dreaminess, and auditory and visual enhancement.

One or two joints or pipes of marijuana (or hashish) will stay in the user's system for two or three days at levels that can be detected by a urine specimen analysis. If the use occurs three or four times a week, however, the metabolite stays in the system from 2-11 weeks.

## Symptoms of marijuana

RELAXED INHIBITIONS  
INCREASED APPETITE  
ODOR OF INCREASE, BURNING ROPE  
IRRITATED MUCOUS MEMBRANCES  
DRY MOUTH  
ERRORS IN JUDGMENT  
GENERAL APATHY  
MOODINESS  
LOSS OF ENERGY

## **COCAINE**

Cocaine is a powerfully addictive stimulant that is typically inhaled, swallowed or injected. Crack, a potent form of cocaine, is often smoked. Cocaine creates an initial surge of excitement followed by a sense of increased energy, alertness and an inflated sense of self-esteem. The effect last only a short time, which tends to make users want to repeat the dose.

Cocaine may be detected in the urine sample for 2-4 days after use.

## Symptoms of cocaine

NASAL PROBLEMS  
SINUSITIS  
SLEEP DISORDERS  
ANXIETY DISORDERS  
RESTLESSNESS  
INITIAL ALERTNESS  
COMBATIVENESS  
TREMORS  
SEIZURES  
DILATED PUPILS  
INCREASED SENSE OF SELF-ESTEEM

## **OPIATES**

Opium, morphine, codeine and synthetic narcotics like Percodan, Demerol and Darvon are typically injected or swallowed. Opiates are depressants that cause drowsiness and slowed heart rate along with euphoria. When heroin is injected it reaches the brain in 15 to 30 seconds and the effect last to three to five hours.

Opiates generally can be detected in urine sample for 1-2 days after use.



## Symptoms of Opiates

- CONSTRICTED PUPILS
- SLOWED SPEECH
- SLOW BREATHING
- SWEATING
- CHILLS
- MUSCLE ACHES
- NAUSEA
- VOMITING
- DROWSINESS

## **AMPHETAMINES**

Amphetamines (speed, whites, black beauties, bennies, crank) are swallowed or injected to enhance performance and alertness, reduce fatigue and suppress appetite. Depending on the dosage and quality, the drug may also bring auditory, visual to tactile hallucinations.

Amphetamines generally can be detected in a urine sample for 1 – 2 days after use.

### **SYMPTOMS OF AMPHETAMINES**

- DEPRESSION
- EXHAUSTION
- AGITATION
- APATHY
- DIFFICULTY CONCENTRATING
- TREMORS
- DRY MOUTH
- PROFUSE SWEATING
- INABILITY TO SLEEP

## **PCP (PHENCYCLIDINE)**

PCP OR angel dust is a hallucinogenic drug that is smoked, swallowed, inhaled or injected. Once used as a veterinary tranquilizer, it was outlawed because its side-effects were deemed too negative even for animals.

Effects vary from user to user depending on biology, circumstances and how the drug was formulated. The effect is perception – and mood-altering, with swings from euphoria and ecstasy to anxiety and depression. Its use frequently causes time, space and sound illusions.

PCP generally can be detected in urine sample for 2 – 8 days after use.  
Because it is inexpensive, it is often blended with other drugs.

#### SYMPTOMS OF PCP

WEAKNESS  
DIZZINESS  
BLURRED VISION  
INCREASED HEART RATE  
IMPAIRED REASONING  
VIOLENCE  
ABNORMAL STRENGTH